

Thule Sprint 569

> Instructions

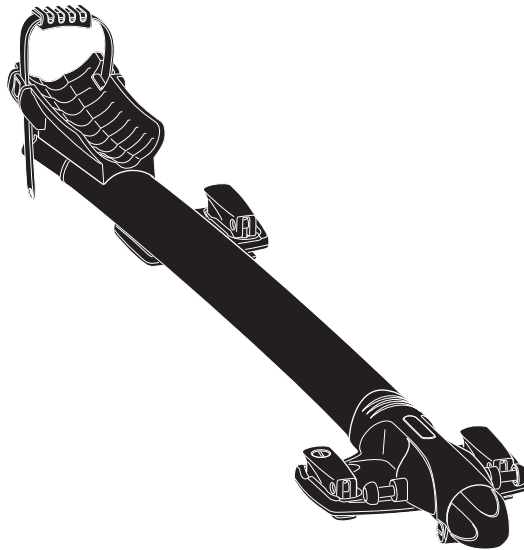

www.thule.com
ID 1000000000

CITY CRASH

Complies with ISO norm



WingBar

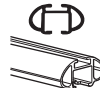

AeroBar



SlideBar



ProBar

569000

C.20141020
501-7906-02

Bring your life
thule.com

EN	Roof-mounted bike carrier	UK	Багажник для велосипедів, що монтується на даху	HE	
DE	Dachfahrradträger	BG	Покривен багажник за велосипеди	AR	
FR	Porte-vélo sur le toit	CS	Nosič jízdních kol s montáží na střechu		
NL	Fietsdrager voor op het dak	SK	Nosič bicyklov s montážou na strechu		
IT	Portabici da installare sul tetto	SL	Nosilec za kolesa		
ES	Portabicicletas de techo	HR/BiH	Krovni nosač bicikla		
PT	Suporte para bicicleta para teto	RO	Suport pentru bicicletă montat pe pavilion		
SV	Takmonterad cykelhållare	HU	Tetőre szerelhető kerékpártartó		
DK	Tagmonteret cykelholder	EL	Σχήμα ποδηλάτου οροφής		
NO	Takmonterte lasteholdere	TR	Araç üstüne bağlanan bisiklet taşıyıcı		
FI	Katolle asennettava polkupyöräteline		حامل الدراجة للتثبيت على السقف		
ET	Katusele paigaldatav jalgrattahoidik		محمل الدراجة للتثبيت على السقف		
LV	Uz jumta uzstādāms velosipēdu turētājs	ZH	頂置自行車架		
LT	Ant stogo tvirtinami dviračių laikikliai	JA	ルーフマウント型サイクルキャリア		
PL	Bagażnik rowerowy montowany na dachu	KO	지붕 장착 자전거 캐리어		
RU	Устанавливаемое на крыше крепление для велосипедов	TH	โครงยึดจักรยานแบบติดตั้งบนหลังคา		















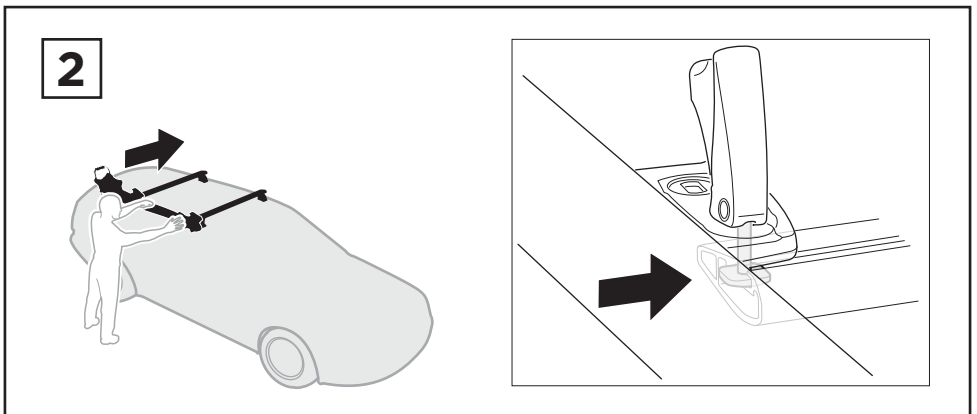
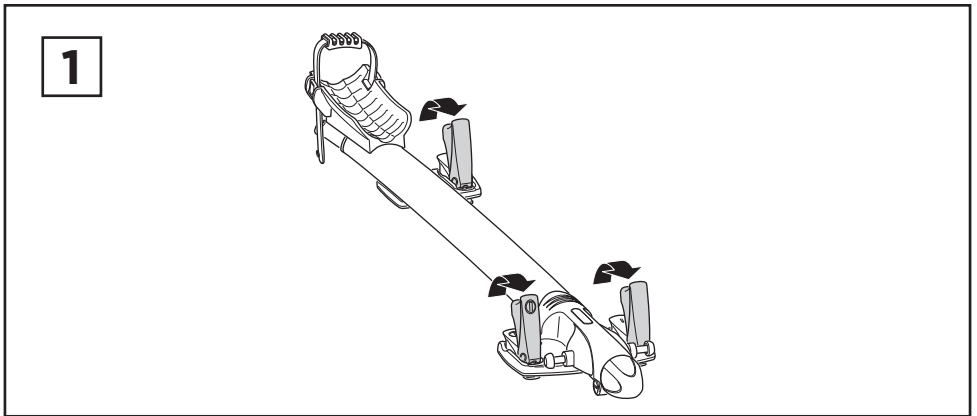
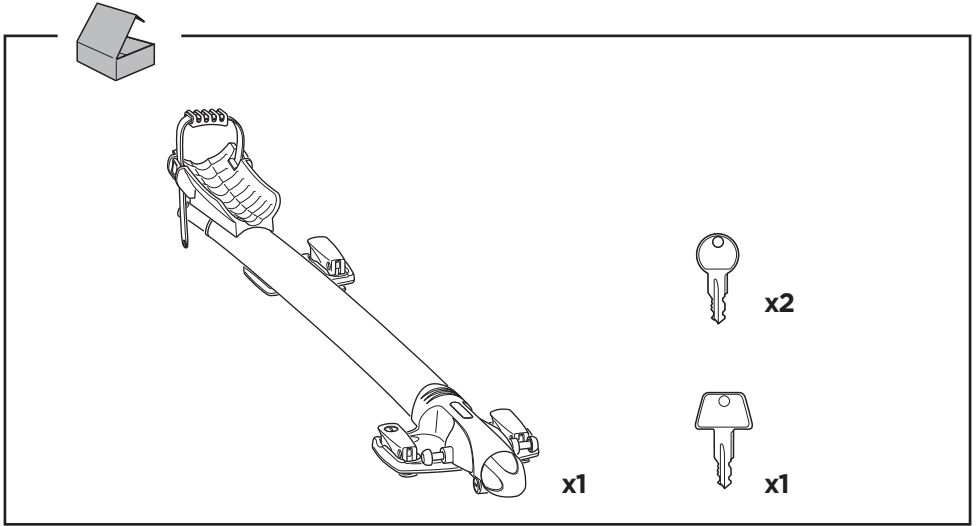

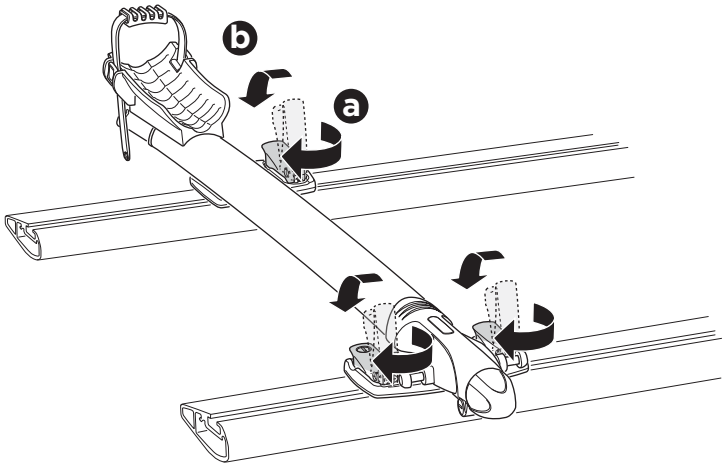
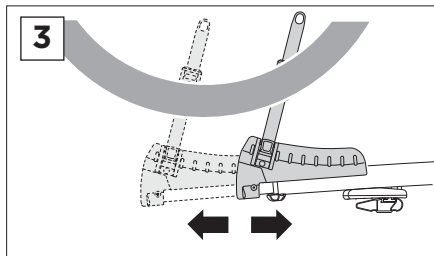
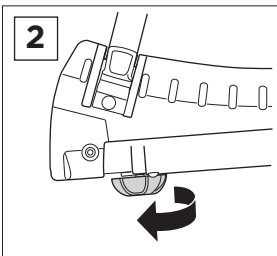
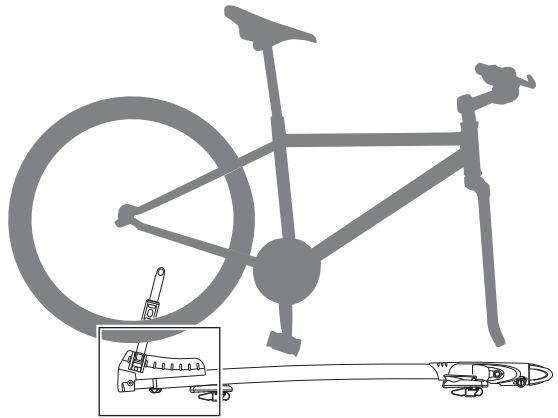
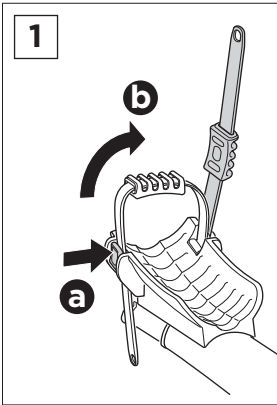
3**4**

5



2

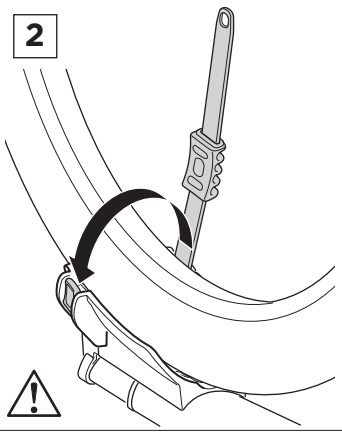

3

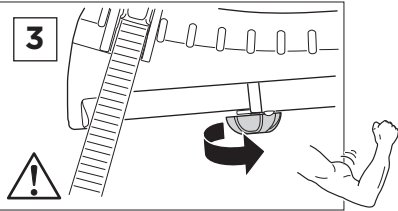

1

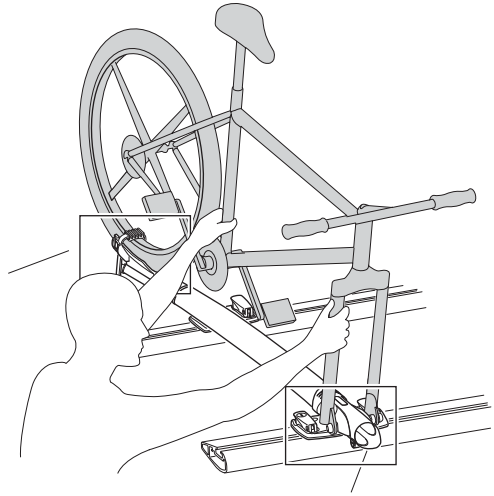
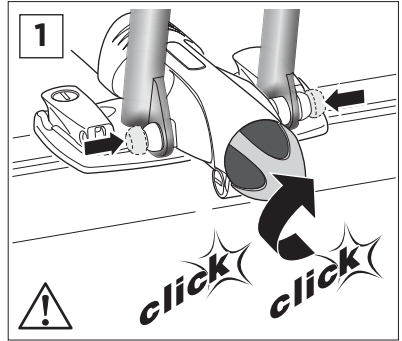

6

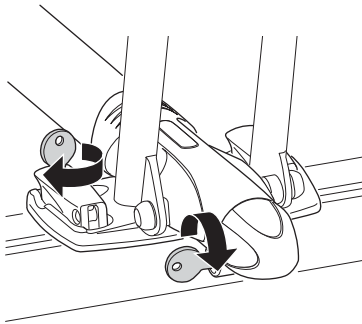

EN Left-hand fitting	BG Монтаж отляво
DE Montage links	CS Montáž z levé strany
FR Montage côté gauche	SK Montáž na ľavej strane
NL Montage aan de linker kant	SL Pritrjevanje z leve strani
IT Montaggio a sinistra	HR/BIH Montaža s lijeve strane
ES Montaje a izquierda	RO Montare pe partea stângă
PT Montagem do lado esquerdo	HU Bal oldalról szerelhető
SV Vänstermonterad	EL Τοποθέτηση αριστερά
DK Venstremontering	TR Sol elle montaj
NO Venstremontering	التركيب في الجانب الأيسر AR
FI Asennus vasemmalle	תהקנה שמאלית HE
ET Vasakpoolne kinnitamine	ZH 从左侧安装
LV Kreisais stiprinājums	JA 左手装着
LT Kairysis pritvirtinimas	KO 왼손 장착
PL Montaż z lewej	TH ตัวยึดด้านซ้ายมือ
RU Установка на левую сторону	
UK Установка на ліву сторону	

i

x1

x1

1

a

b

2

a

b

c

i

1

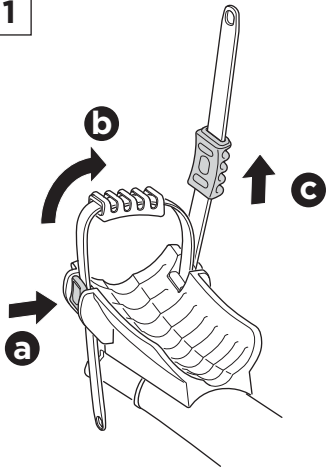

2

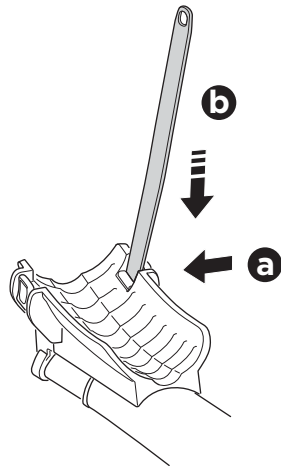

3

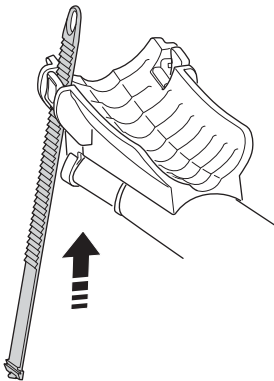

4

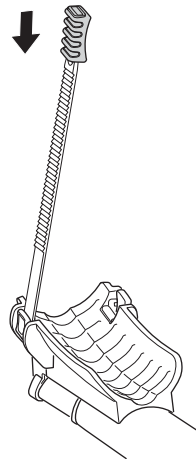

EN Accessories
DE Zubehör
FR Accessoires
NL Accessoires
IT Accessori
ES Accesorios
PT Acessórios
SV Tillbehör
DK Tilbehør
NO Tilbehør
FI Lisävarusteet
ET Lisavarustus
LV Piederumi
LT Priedai
PL Akcesoria
RU Аксессуары

UK Аксессуары
BG Принадлежности
CS Dopřloky
SK Príslušenstvo
SL Dodatki
HR/BiH Dodaci
RO Accesorii
HU Tartozékok
EL Εξαρτήματα
TR Aksesuarlar

AR الملحقا
 HE אביזרים

ZH 附件
JA アクセサリー
KO 액세서리
TH อุปกรณ์เสริม

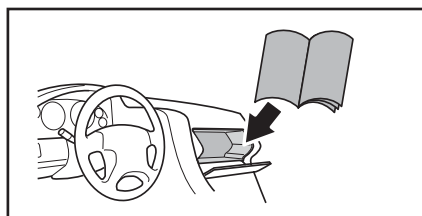
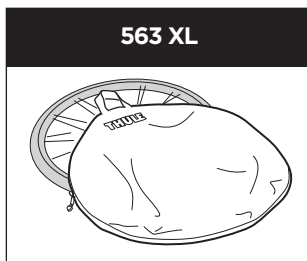
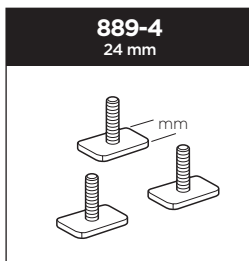
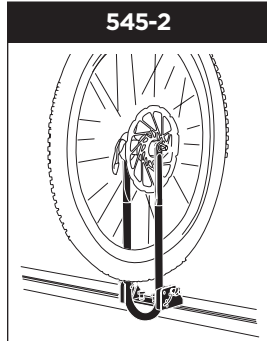

Thule One-Key System

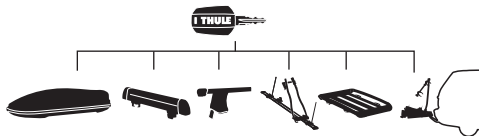

544  (x4)
596  (x6)
588  (x8)
452  (x12)