

# Kit 3044

**VOLKSWAGEN California (T5)**, 4-dr Bus, 03-09, 10-  
**VOLKSWAGEN Caravelle (T5)**, 4-dr Bus, 03-09, 10-  
**VOLKSWAGEN Multivan (T5)**, 4-dr Bus, 03-09, 10-  
**VOLKSWAGEN Shuttle (T5)**, 4-dr Bus, 03-09, 10-  
**VOLKSWAGEN Transporter (T5)**, 4-dr Van, 03-09, 10-

This Kit is only for vehicles with fixpoint mounting or T-profile.

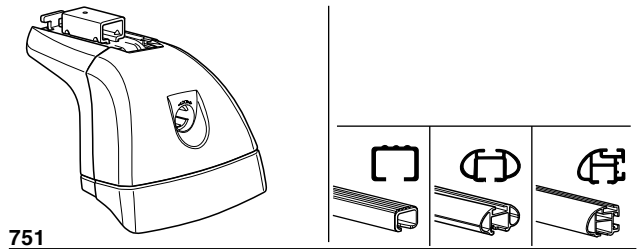

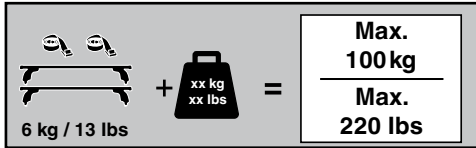

6 kg / 13 lbs + xx kg xx lbs = **Max. 100 kg**  
**Max. 220 lbs**

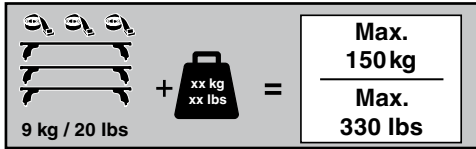

9 kg / 20 lbs + xx kg xx lbs = **Max. 150 kg**  
**Max. 330 lbs**

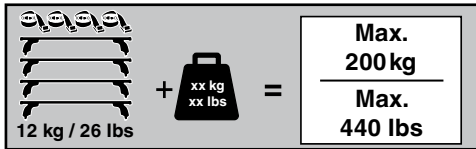

12 kg / 26 lbs + xx kg xx lbs = **Max. 200 kg**  
**Max. 440 lbs**

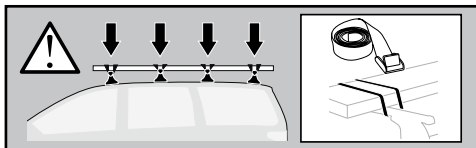
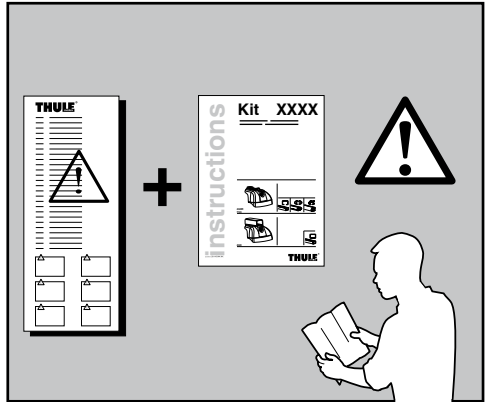
THULE + Kit XXXX

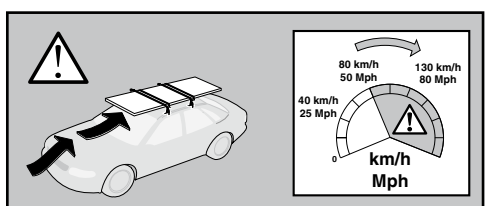

80 km/h 50 Mph 130 km/h 80 Mph  
40 km/h 25 Mph  
**km/h Mph**

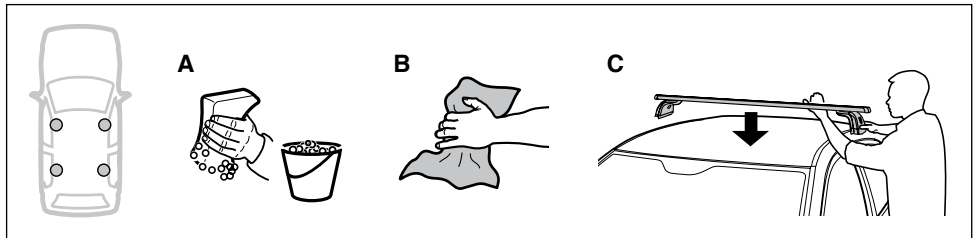

A B C

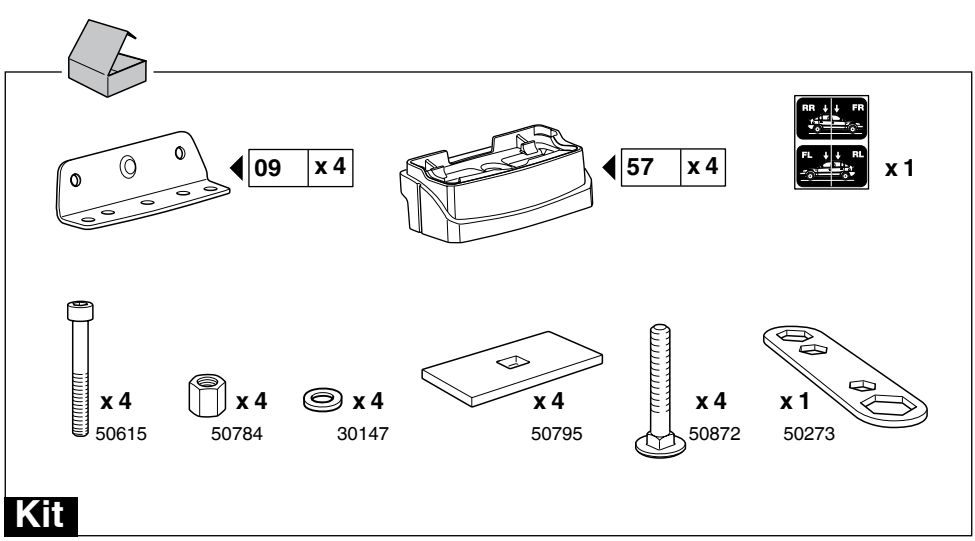

09 x 4 57 x 4 x 1

x 4 x 4 x 4 x 4 x 4 x 1

50615 50784 30147 50795 50872 50273

**Kit**

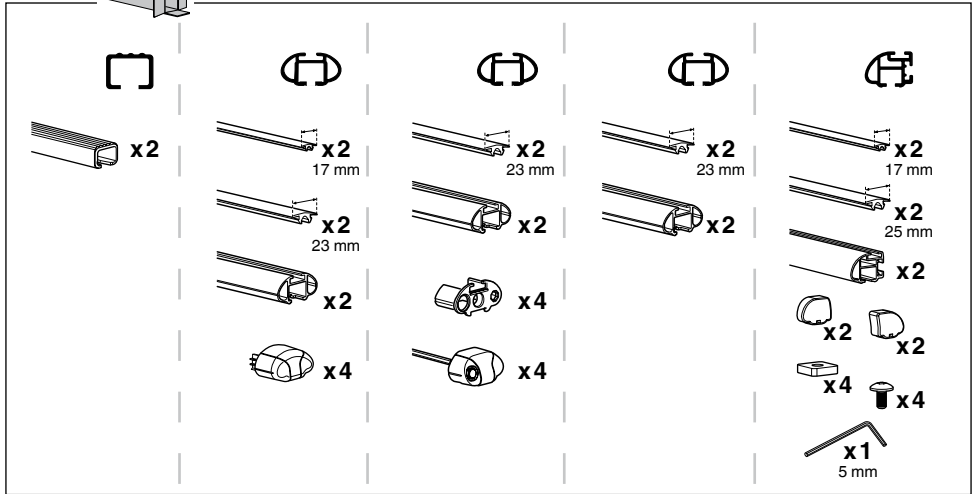
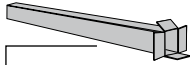
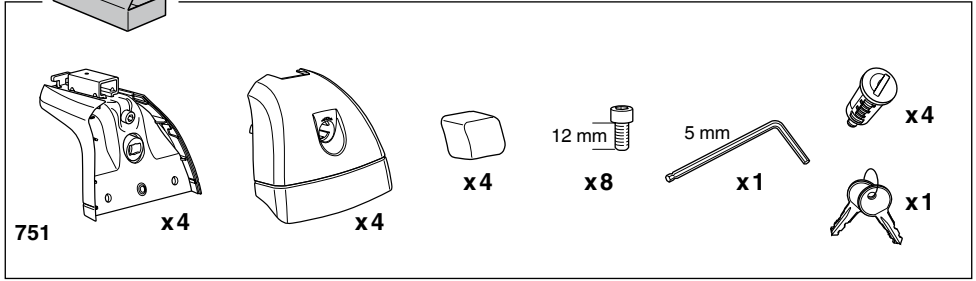
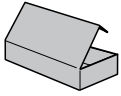

1

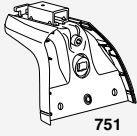

751

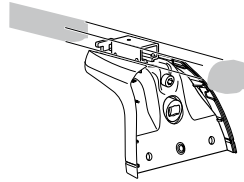
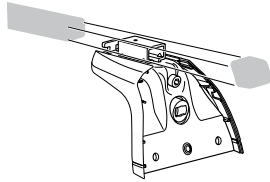
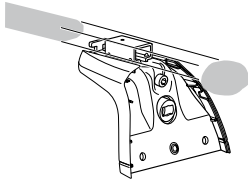

x4

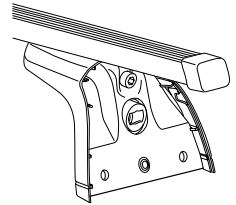
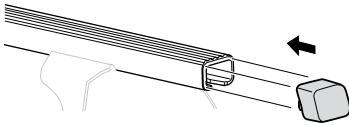

x4

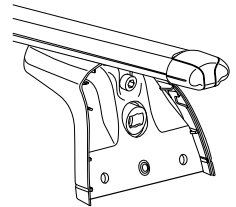
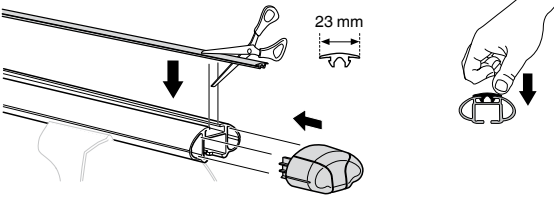

x4

x4

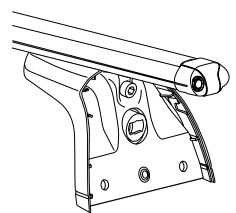
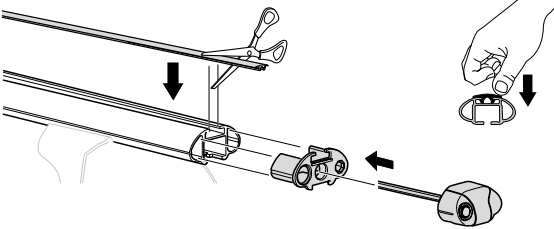

x2

x2

x4

x4

x1

5 mm

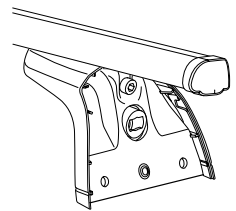
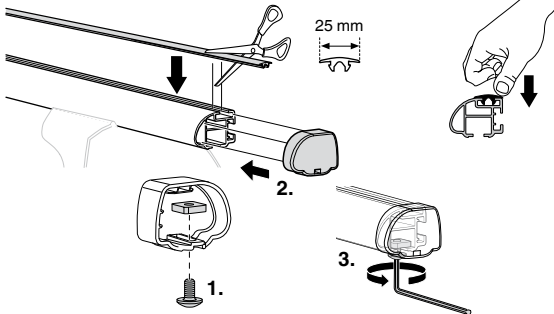

2

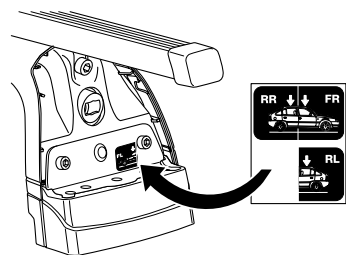
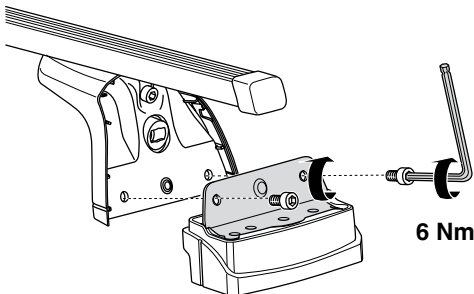
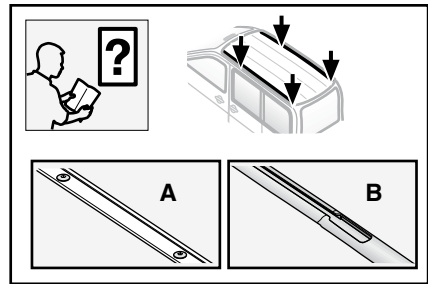
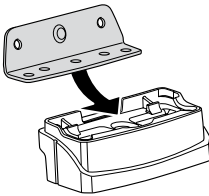
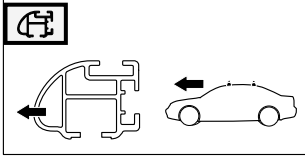
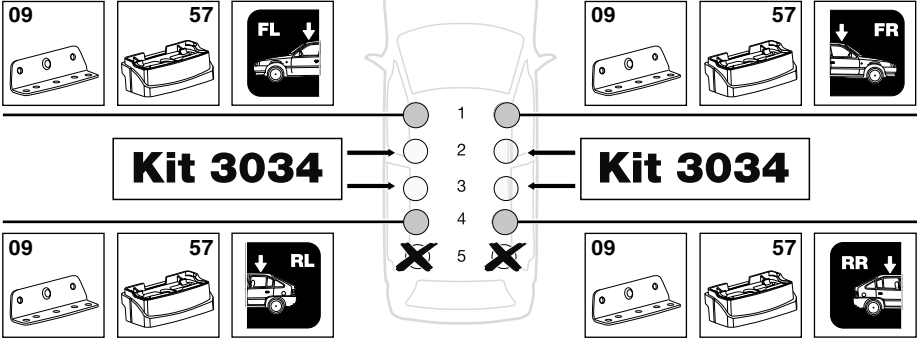
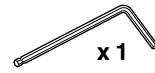
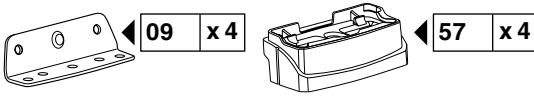

**3**



x4



x4

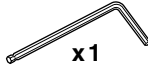

x1

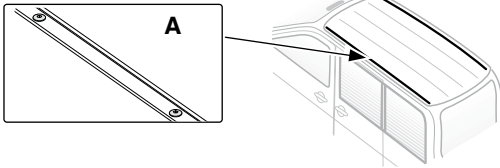
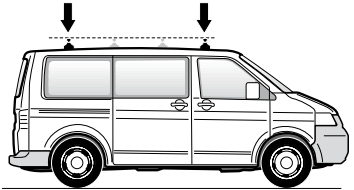

**A**

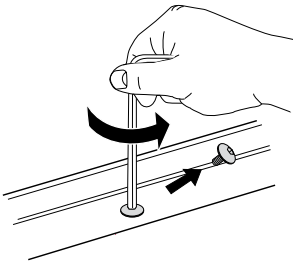

**B**

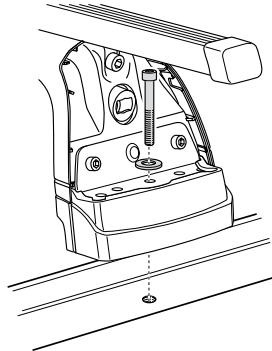

**C**

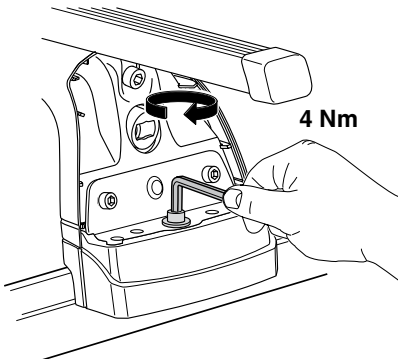

4 Nm

**D**

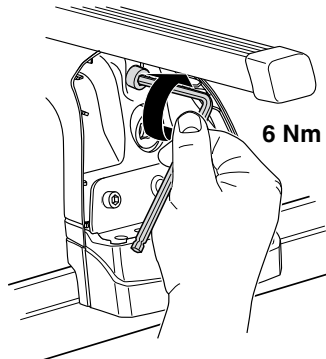

6 Nm

**3**

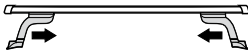
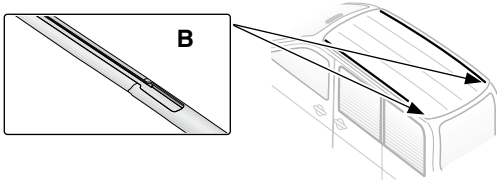
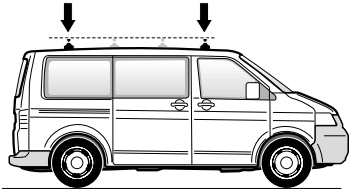
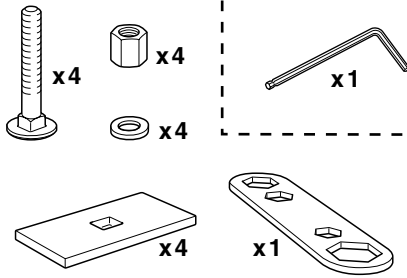

**A**

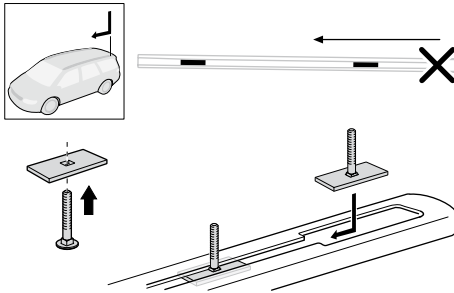

**B**

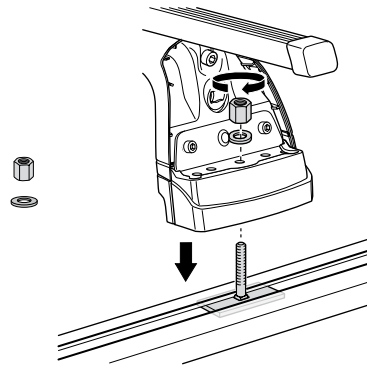

**C**

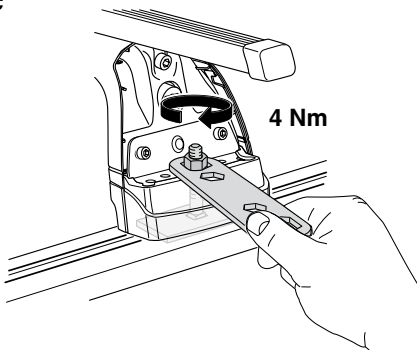

**D**

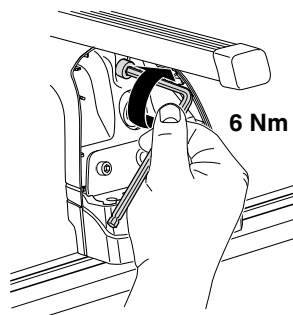

**4**

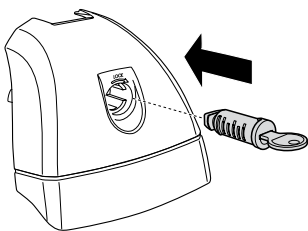

**5**

5 mm

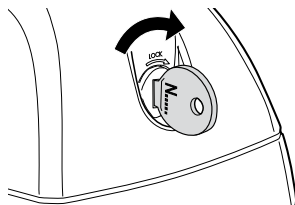
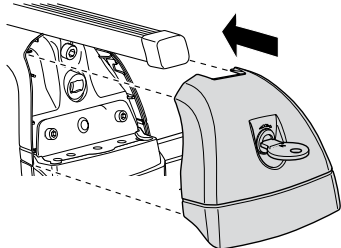
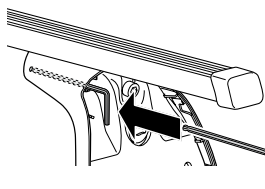

**6**

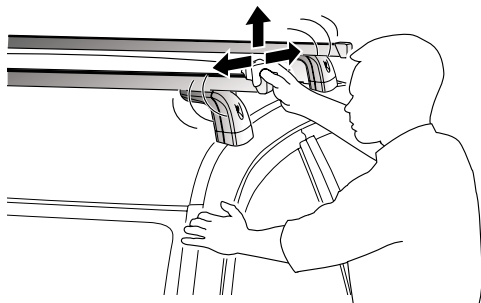



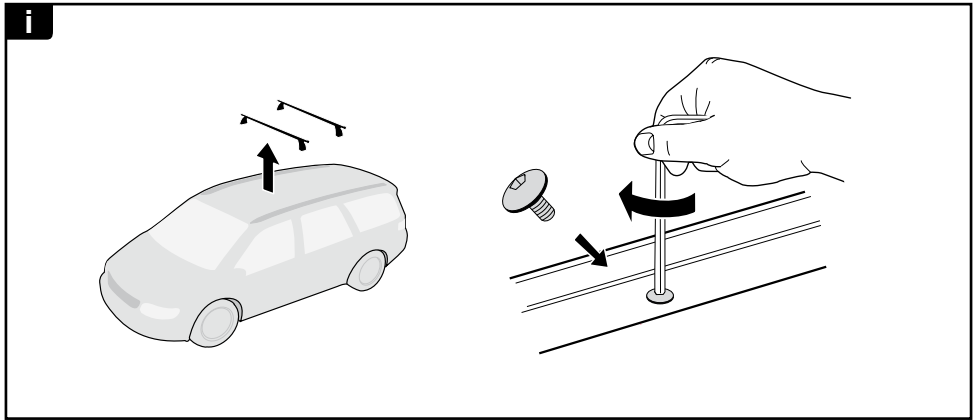
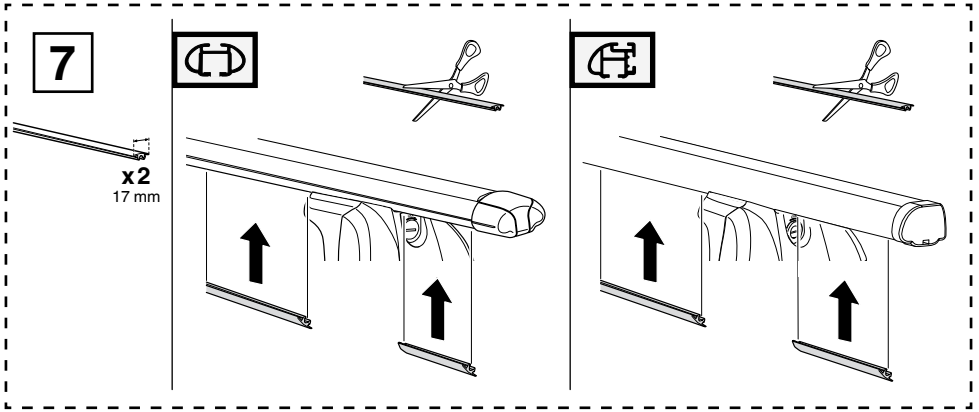





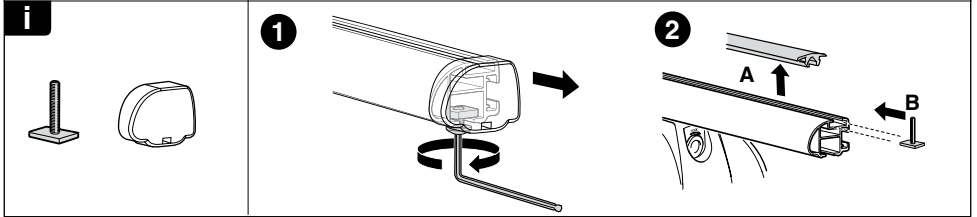
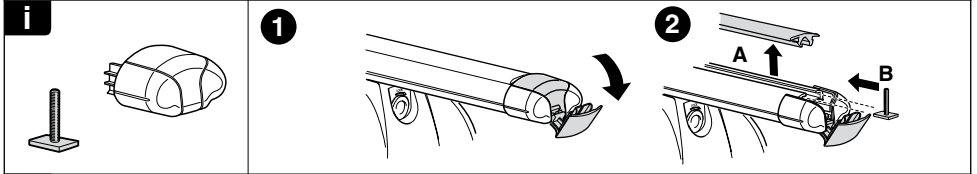
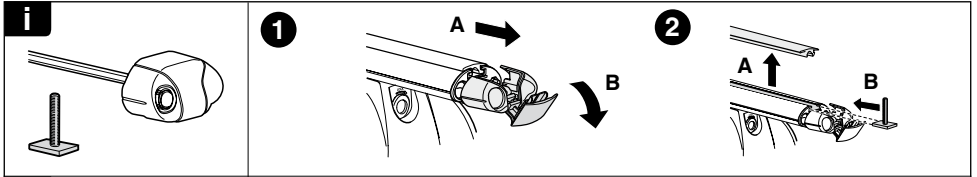
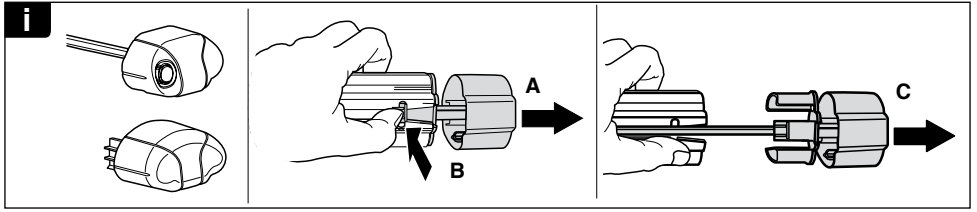

**THULE**  
SWEDEN

**ONE  
KEY  
SYSTEM**

**544** (x4)

**596** (x6)

**588** (x8)

**NA 510** (x10)

**EUR 452** (x12)

**ASIA**