

Kit 1709

KIA K9, 4-dr Sedan, 13–
KIA Quoris, 4-dr Sedan, 13–

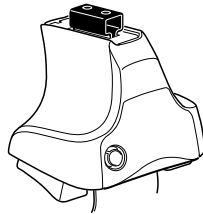

754 Rapid System
480R Rapid Traverse (North America)

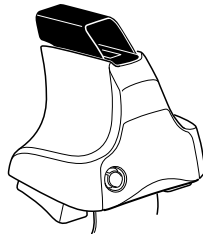
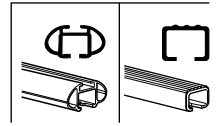

480 Traverse (North America)

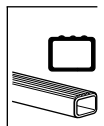

1

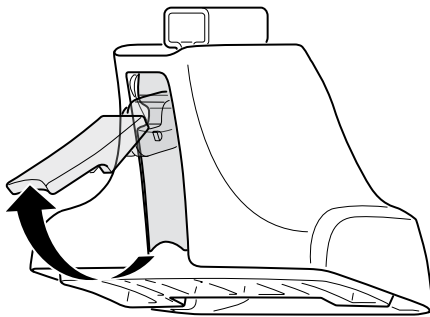

2



754 Rapid System
480R Rapid Traverse
(North America)

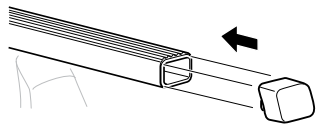
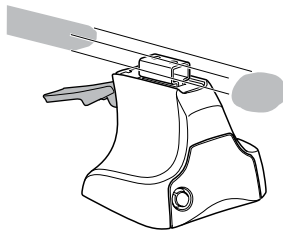

x4

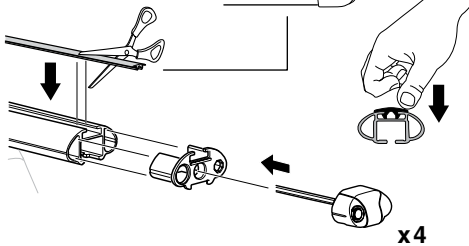
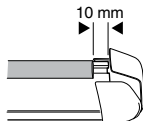
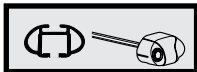

x4

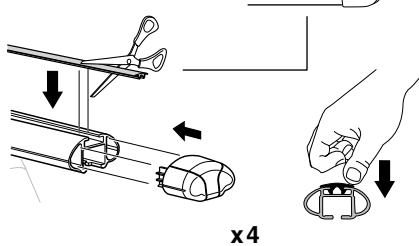
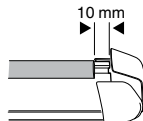
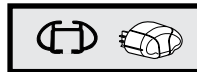

x4



480 Traverse
(North America)

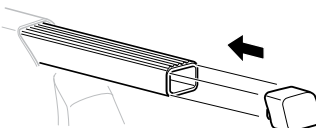
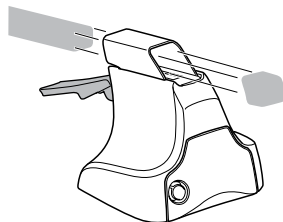

x4

3

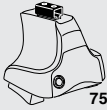

754 Rapid System

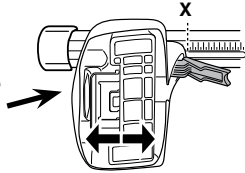

	X
KIA K9, 4-dr Sedan, 13-	46
KIA Quoris, 4-dr Sedan, 13-	46

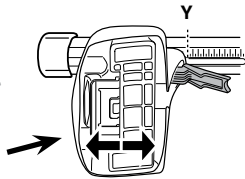

	Y
KIA K9, 4-dr Sedan, 13-	41,5
KIA Quoris, 4-dr Sedan, 13-	41,5

3



480R Rapid Traverse



480 Traverse

(North America)

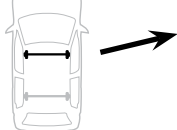

	X inch	X mm
KIA K9, 4-dr Sedan, 13-	43 3/4"	1111 mm
KIA Quoris, 4-dr Sedan, 13-	43 3/4"	1111 mm

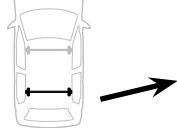

	Y inch	Y mm
KIA K9, 4-dr Sedan, 13-	42"	1066 mm
KIA Quoris, 4-dr Sedan, 13-	42"	1066 mm

4

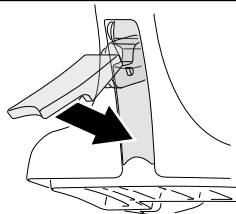

5

KIA K9, 4-dr Sedan, 13-
 KIA Quoris, 4-dr Sedan, 13-

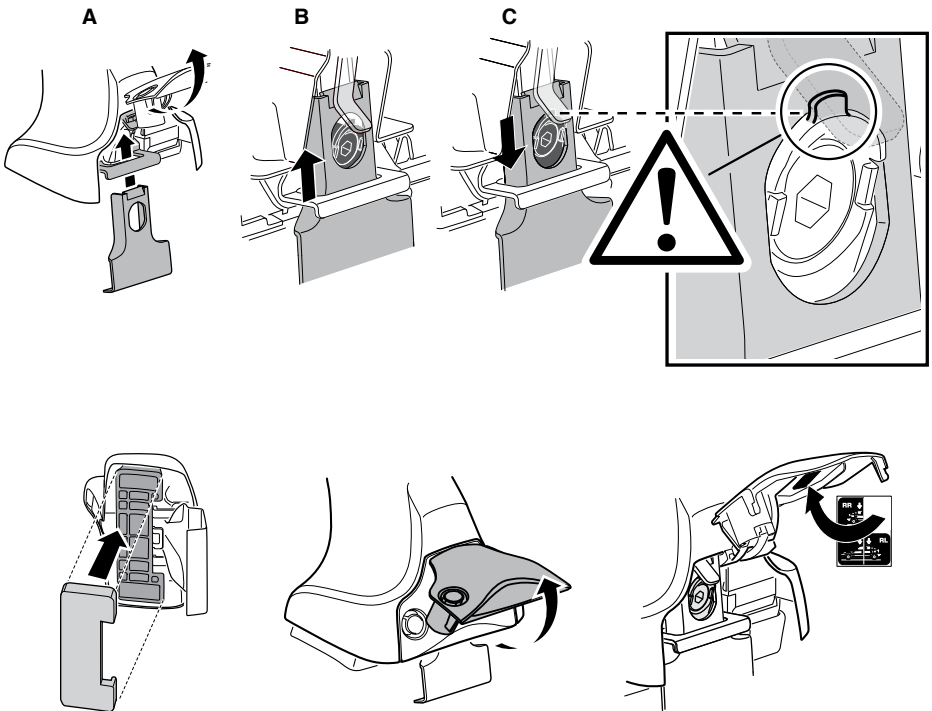
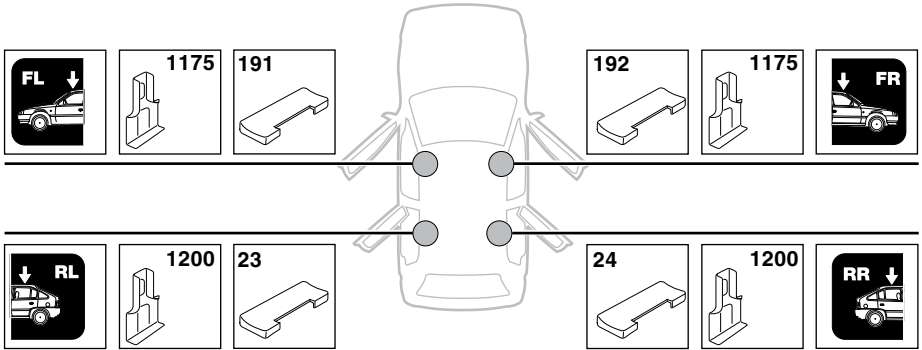

6

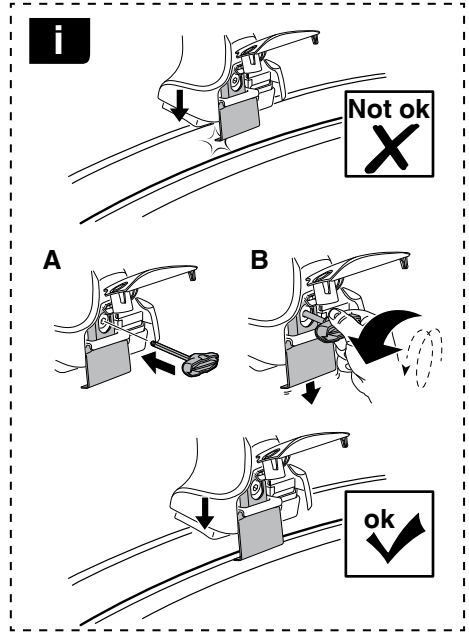
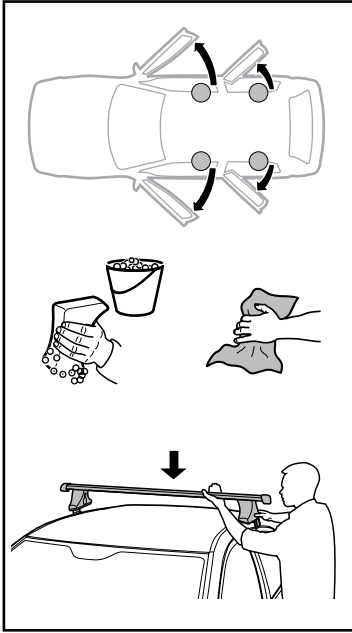

	X mm	Y mm	X inch	Y inch
KIA K9, 4-dr Sedan, 13-	330 mm	700 mm	13"	27 1/2"
KIA Quoris, 4-dr Sedan, 13-	330 mm	700 mm	13"	27 1/2"

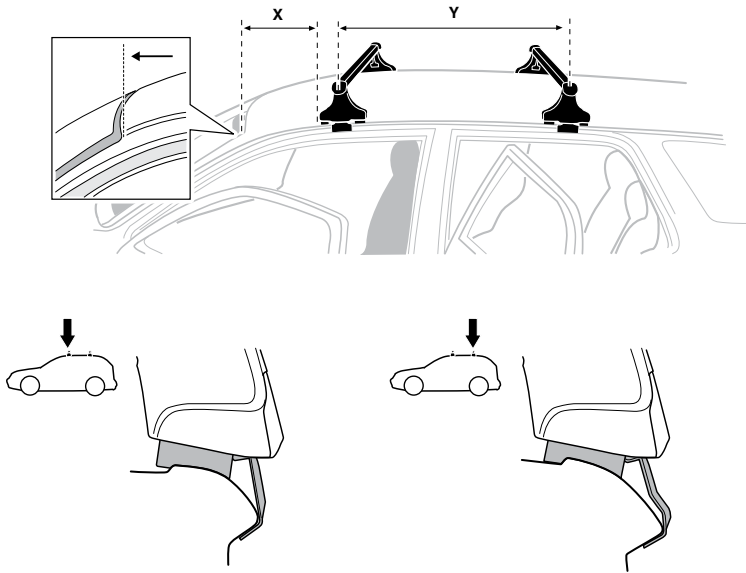

7

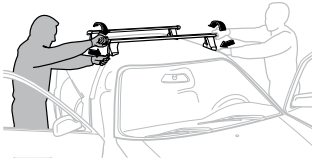

GB/US	Tighten alternately
D	Die Schrauben abwechselnd anziehen
F	Serrer alternativement chaque côté
NL	Afwisselend aan de linker- en de rechterkant aandraaien
I	Alternare il serraggio delle viti
E	Apertar alternativamente
PT	Aperte alternadamente
S	Dra åt växelvis
FIN	Kierrä vuorotellen
EST	Pinguldage vaheldumisi
LAT	Pielveiciet pamišus
LIT	Užsukinėkite pakaitomis
PL	Śruby dokręcaj naprzemiennie
RU	Загтягивайте попеременно

CZ	Pokręřta багаžnika dokręcaj naprzemiennie.
SK	Dofahajte striedavo
SLO	Privijajte izmenično.
HR	Naizmjenično zategnite
HU	Egymástól függetlenül szorítandó
GR	Σφιγίγτες εναλλάξ
TR	Dönüşümlü sıkın

中文 交替拧紧

한국어 번갈아 가며 조이십시오.

日本語 交互に締め付けてください。

ไทย ชันในแบบสลับ

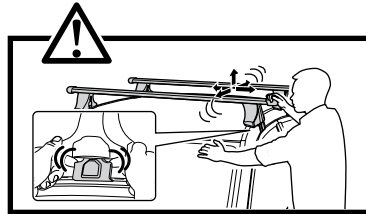
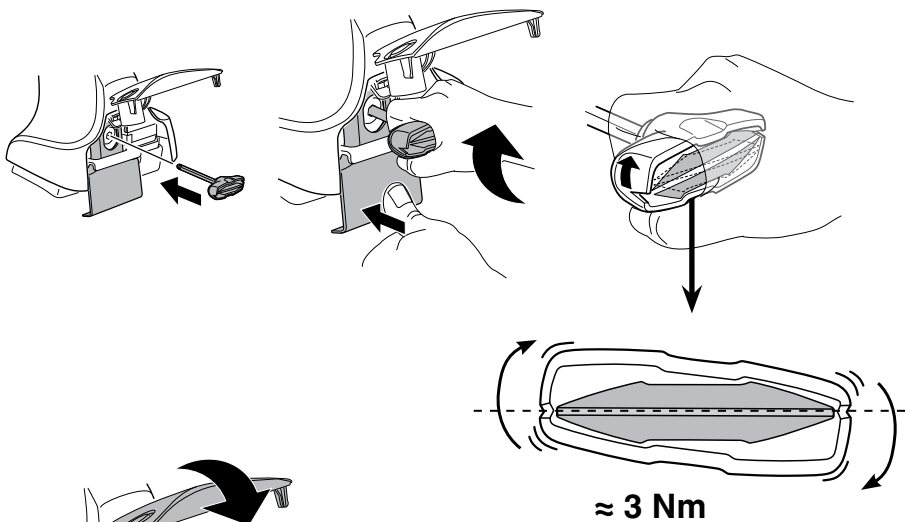

8



x1
17 mm

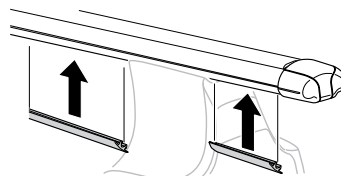
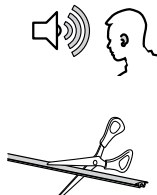

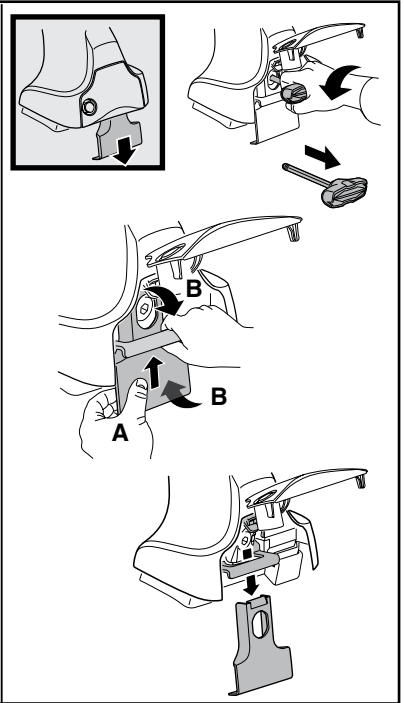
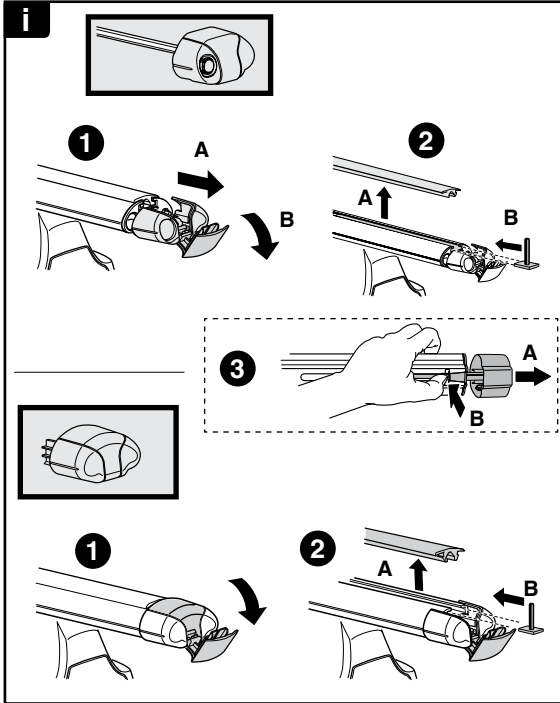
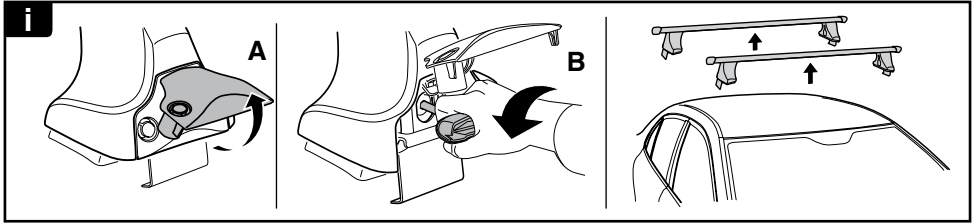

THULE
SWEDEN
**ONE
KEY
SYSTEM**

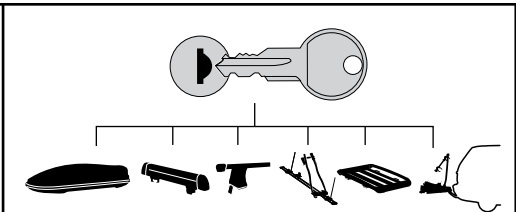

		(x4)
		(x6)
		(x8)
NA		(x10)
EUR		(x12)
ASIA		

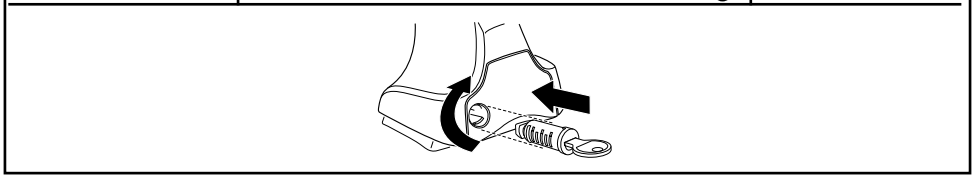

WW ▶ Thule Sweden AB, Box 69, 330 33 Hillerstorp, SWEDEN
NA ▶ Thule Inc., 42 Silvermine Road, Seymour, Connecticut 06483, USA

info@thule.com
customer.service@thule.com

www.thule.com