

# Kit 1662

HONDA Fit Shuttle, 5-dr MPV, 11-

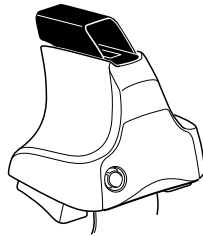

**754** Rapid System  
**480R** Rapid Traverse (North America)

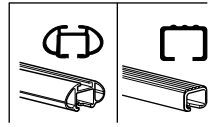

**480** Traverse (North America)

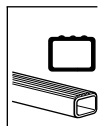



1



2



754 Rapid System  
480R Rapid Traverse  
(North America)

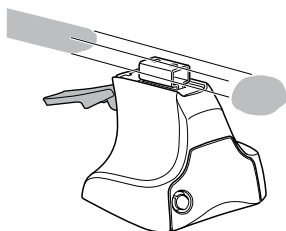

x4

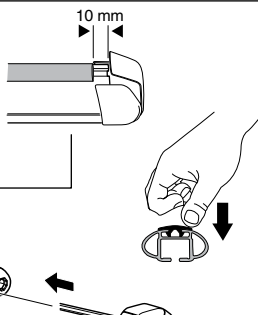
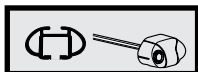

x4

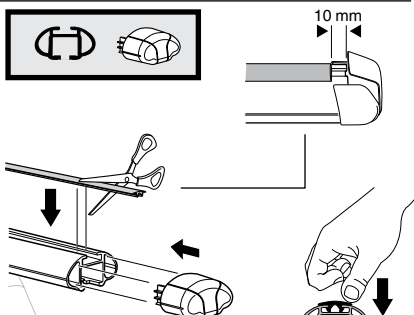
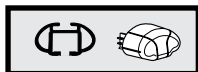

x4



480 Traverse  
(North America)

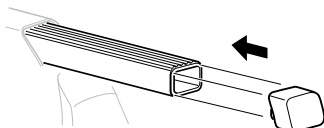

x4

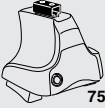
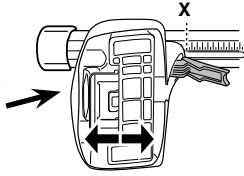
**3****754** Rapid System

	<b>X</b>
<b>HONDA Fit Shuttle, 5-dr MPV, 11-</b>	<b>33,5</b>

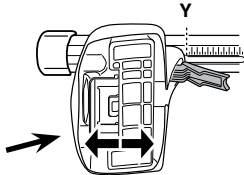

	<b>Y</b>
<b>HONDA Fit Shuttle, 5-dr MPV, 11-</b>	<b>27</b>

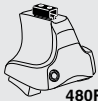
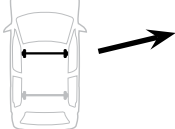
**3****480R** Rapid Traverse**480** Traverse**(North America)**

	<b>X inch</b>	<b>X mm</b>
<b>HONDA Fit Shuttle, 5-dr MPV, 11-</b>	<b>38 7/8"</b>	<b>986 mm</b>

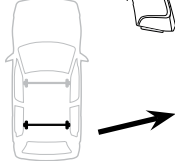

	<b>Y inch</b>	<b>Y mm</b>
<b>HONDA Fit Shuttle, 5-dr MPV, 11-</b>	<b>36 1/4"</b>	<b>921 mm</b>

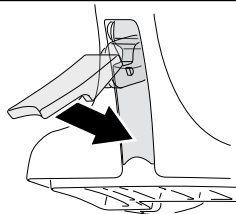
**4**

# 5

HONDA Fit Shuttle, 5-dr MPV, 11-

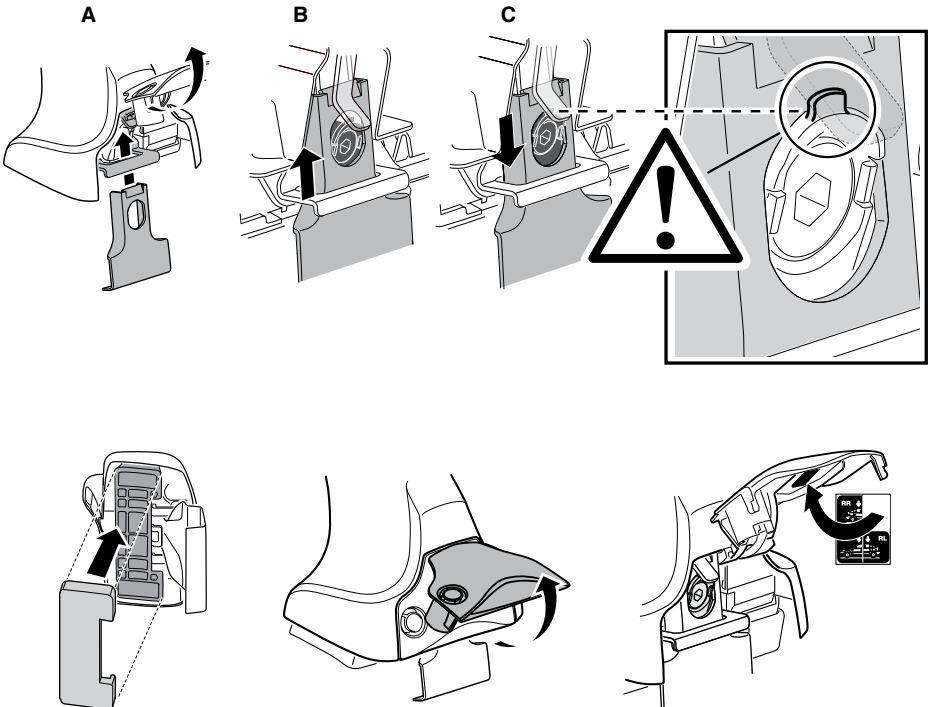
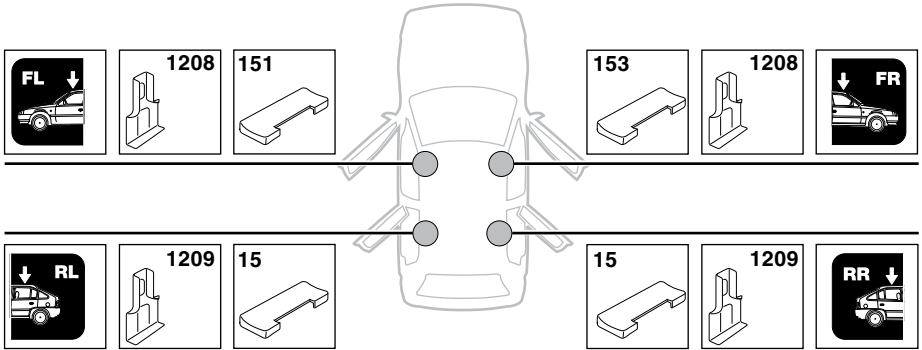

6

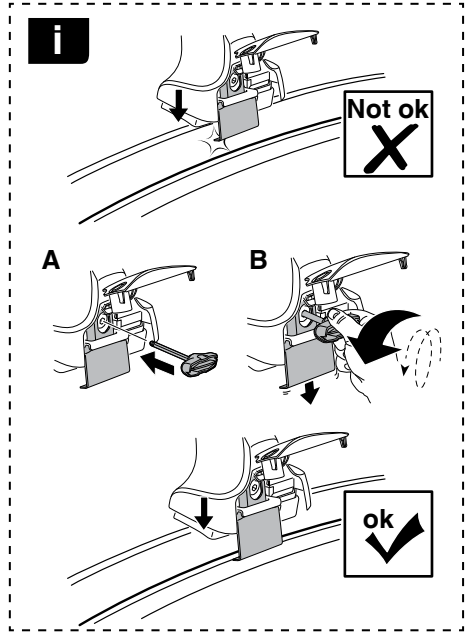

HONDA Fit Shuttle, 5-dr MPV, 11-

X mm	Y mm	X inch	Y inch
370 mm	700 mm	14 <sup>5</sup> / <sub>8</sub> "	27 <sup>1</sup> / <sub>2</sub> "

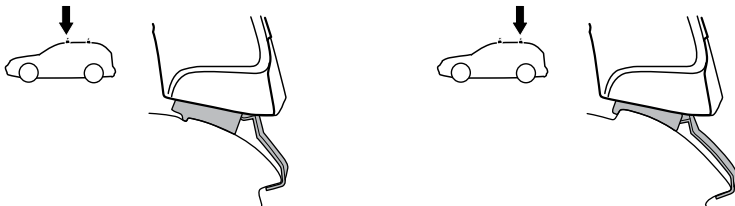
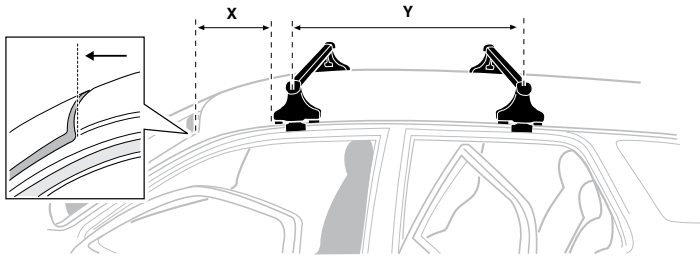

7

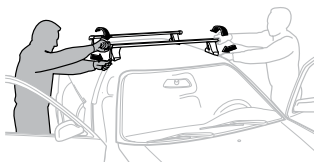

GB/US Tighten alternately  
 D Die Schrauben abwechselnd anziehen  
 F Serrer alternativement chaque côté  
 NL Afwisselend aan de linker- en de rechterkant aandraaien  
 I Alternare il serraggio delle viti  
 E Apertar alternativamente  
 PT Aperte alternadamente  
 S Dra åt växelvis  
 FIN Kierrä vuorotellen  
 EST Pinguldage vaheldumisi  
 LAT Pieļieciet pamišus  
 LIT Užsukinėkite pakaitomis  
 PL Śruby dokręcaj naprzemiennie  
 RU Затягивайте попеременно

CZ Pokręťta bagażnika dokręcaj dokręcaj naprzemiennie.  
 SK Dofahajte striedavo  
 SLO Privijajte izmenično.  
 HR Naizmjenično zategnite  
 HU Egymástól függetlenül szorítandó  
 GR Σφιγίγτες εναλλάξ  
 TR Dönüşümlü sıkın

中文 交替拧紧

한국어 번갈아 가며 조이십시오.

日本語 交互に締め付けてください。

ไทย ชันในแบบสลับ

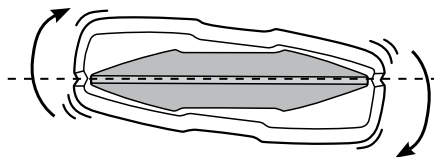
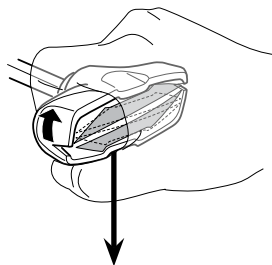
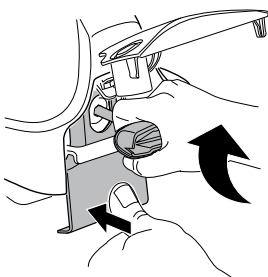
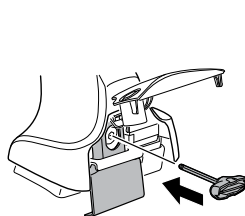

≈ 3 Nm

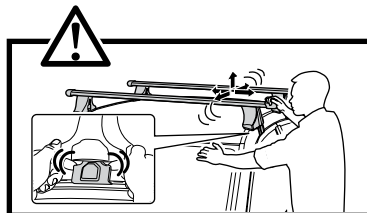
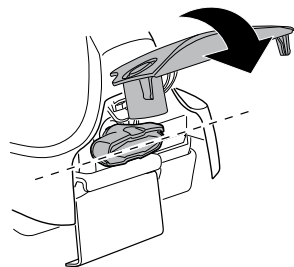

8



x1  
17 mm

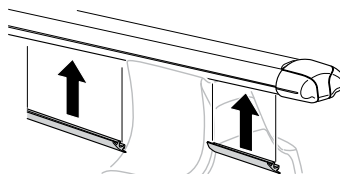
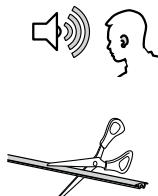

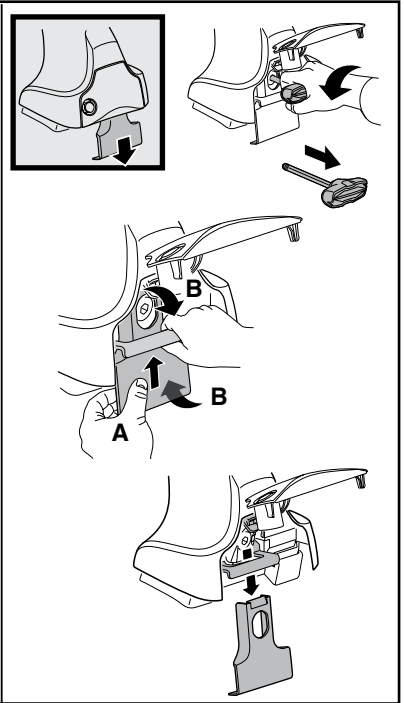
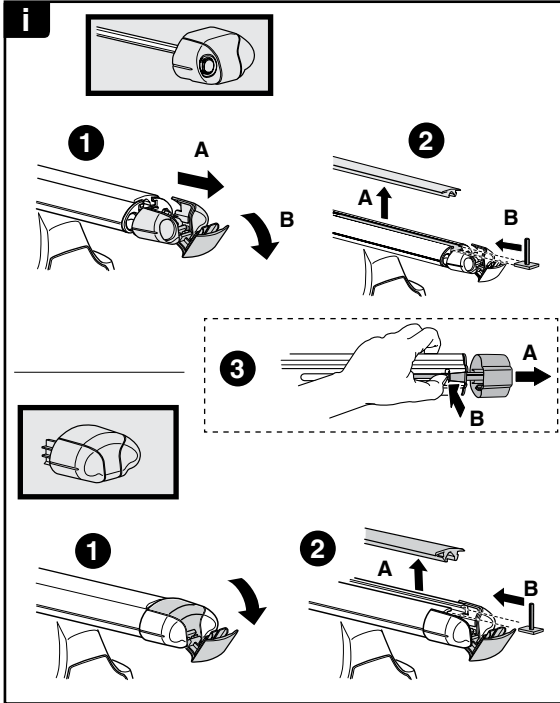

**THULE**  
SWEDEN  
**ONE  
KEY  
SYSTEM**



		(x4)
		(x6)
		(x8)
NA		(x10)
EUR		(x12)
ASIA		



WW ▶ Thule Sweden AB, Box 69, 330 33 Hillerstorp, SWEDEN  
NA ▶ Thule Inc., 42 Silvermine Road, Seymour, Connecticut 06483, USA

info@thule.com  
customer.service@thule.com

www.thule.com