

# Kit 1654

**HYUNDAI Avante**, 4-dr Sedan, 11–  
**HYUNDAI Elantra**, 4-dr Sedan, 11–

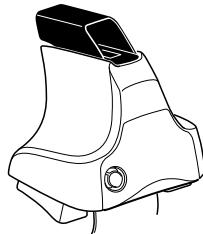

**754** Rapid System  
**480R** Rapid Traverse (North America)

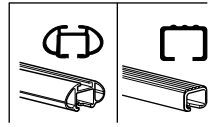

**480** Traverse (North America)

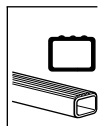

xx kg  
xx lbs + 7 kg  
15,4 lbs = **Max. 50 kg**  
**Max. 110 lbs**

80 km/h  
50 Mph  
130 km/h  
80 Mph  
40 km/h  
25 Mph  
**km/h  
Mph**

**THULE**  
**Kit XXXX**  
**instructions**  
**THULE**

**x1**  
**x4**  
**754 Rapid System**  
**480R Rapid Traverse (North America)**  
**x4**  
**x4**

**x1**  
**x4**  
**x4**  
**754 Rapid System**  
**480R Rapid Traverse (North America)**  
**x4**  
**x4**  
**480 Traverse (North America)**

(North America)  
**x2**  
**x2**  
**x2**  
**x4**  
**x4**  
**x2**  
**x2**  
**x2**  
**x2**  
**x2**  
**x2**  
**x2**  
**x2**  
**x2**  
**x2**

**1194 x4**  
**204 x1**  
**206 x1**  
**237 x1**  
**238 x1**  
**x1**

1

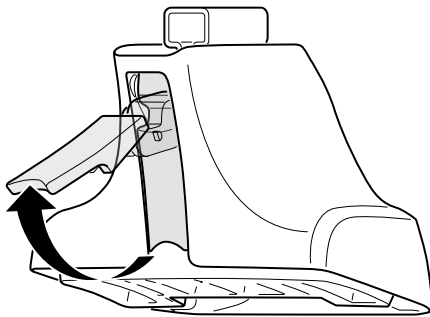

2



754 Rapid System  
480R Rapid Traverse  
(North America)

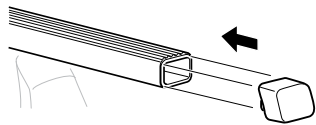
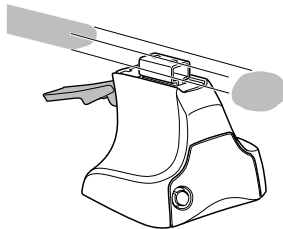

x4

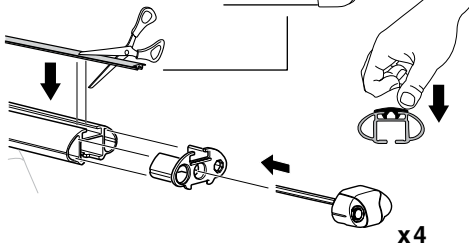
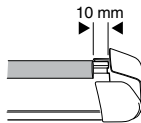
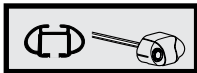

x4

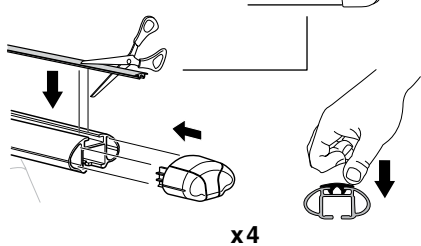
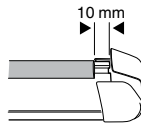
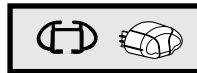

x4



480 Traverse  
(North America)

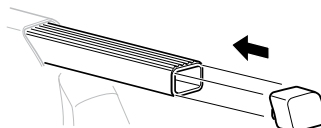
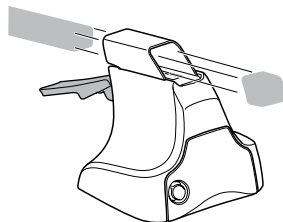

x4

**3**

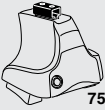

**754** Rapid System

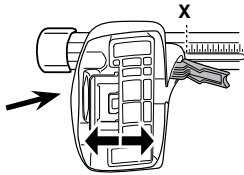

**X**

<b>HYUNDAI Avante</b> , 4-dr Sedan, 11-	<b>43</b>
<b>HYUNDAI Elantra</b> , 4-dr Sedan, 11-	<b>43</b>

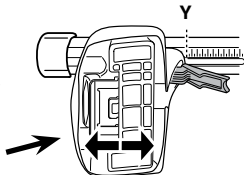

**Y**

<b>HYUNDAI Avante</b> , 4-dr Sedan, 11-	<b>42</b>
<b>HYUNDAI Elantra</b> , 4-dr Sedan, 11-	<b>42</b>

**3**



**480R** Rapid Traverse



**480** Traverse

**(North America)**

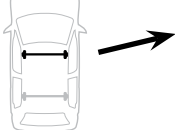

**X inch**      **X mm**

<b>HYUNDAI Avante</b> , 4-dr Sedan, 11-	<b>42 1/2"</b>	<b>1081 mm</b>
<b>HYUNDAI Elantra</b> , 4-dr Sedan, 11-	<b>42 1/2"</b>	<b>1081 mm</b>

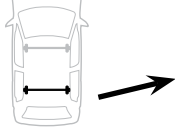

**Y inch**      **Y mm**

<b>HYUNDAI Avante</b> , 4-dr Sedan, 11-	<b>42 1/8"</b>	<b>1071 mm</b>
<b>HYUNDAI Elantra</b> , 4-dr Sedan, 11-	<b>42 1/8"</b>	<b>1071 mm</b>

**4**

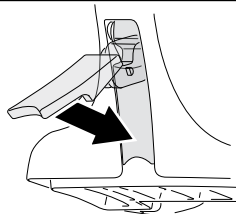

# 5

HYUNDAI Avante, 4-dr Sedan, 11-  
 HYUNDAI Elantra, 4-dr Sedan, 11-

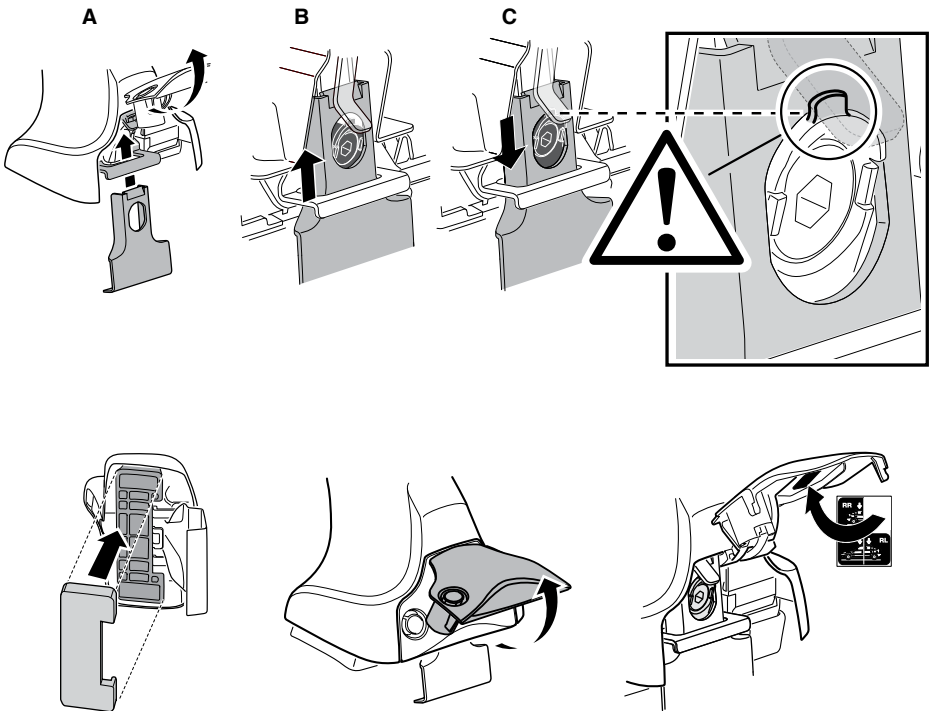
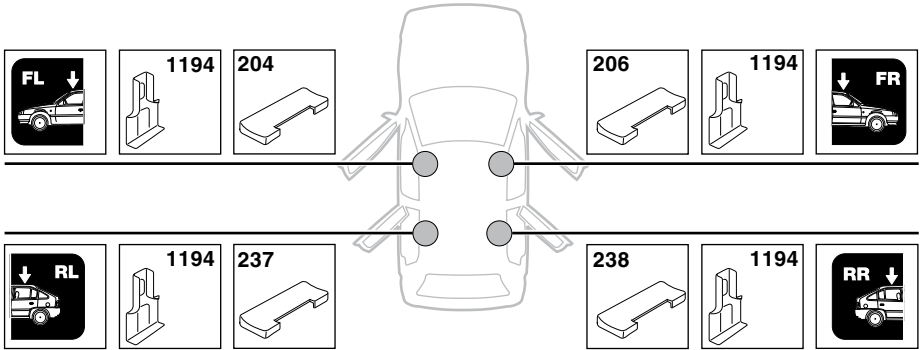

6

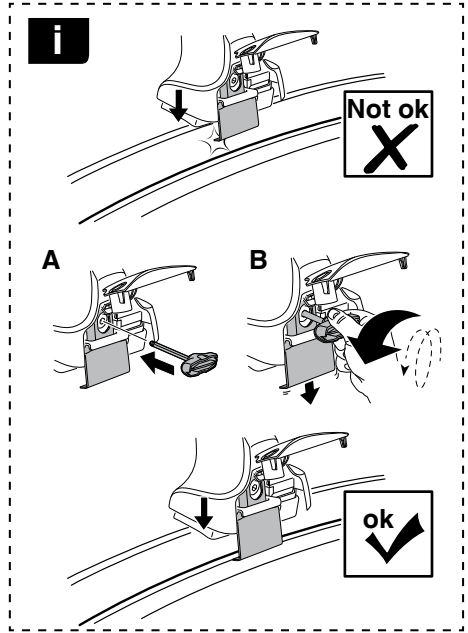

	X mm	Y mm	X inch	Y inch
HYUNDAI Avante, 4-dr Sedan, 11-	225 mm	685 mm	8 <sup>7</sup> / <sub>8</sub> "	27 "
HYUNDAI Elantra, 4-dr Sedan, 11-	225 mm	685 mm	8 <sup>7</sup> / <sub>8</sub> "	27 "

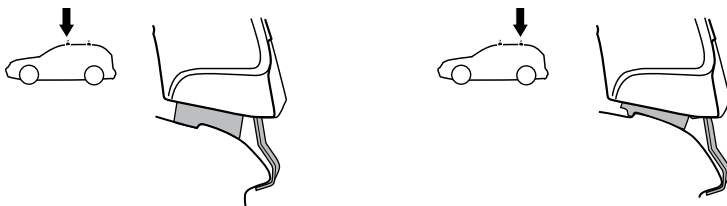
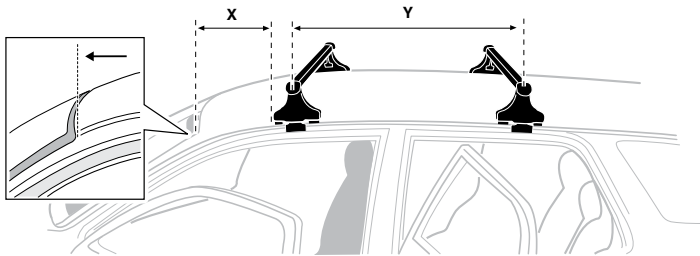

7

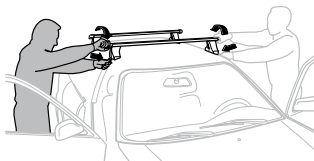

**GB/US** Tighten alternately  
**D** Die Schrauben abwechselnd anziehen  
**F** Serrer alternativement chaque côté  
**NL** Afwisselend aan de linker- en de rechterkant aandraaien  
**I** Alternare il serraggio delle viti  
**E** Apertar alternativamente  
**PT** Aperte alternadamente  
**S** Dra åt växelvis  
**FIN** Kierrä vuorotellen  
**EST** Pinguldage vaheldumisi  
**LAT** Pieļieciet pamišus  
**LIT** Užsukinėkite pakaitomis  
**PL** Śruby dokręcaj naprzemiennie  
**RU** Затягивайте попеременно

**CZ** Pokręťta bagażnika dokręcaj naprzemiennie.  
**SK** Dofahajte striedavo  
**SLO** Privijajte izmenično.  
**HR** Naizmjenočno zategnite  
**HU** Egymástól függetlenül szorítandó  
**GR** Σφιγίγτες εναλλάξ  
**TR** Dönüşümlü sıkın

**中文** 交替拧紧

**한국어** 번갈아 가며 조이십시오.

**日本語** 交互に締め付けてください。

**ไทย** ชันในแบบสลับ

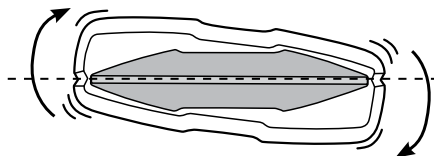
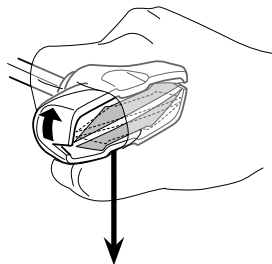
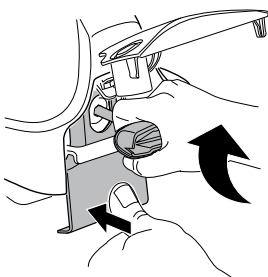
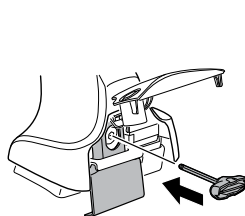

≈ 3 Nm

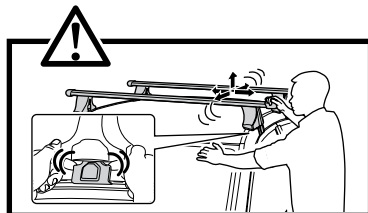
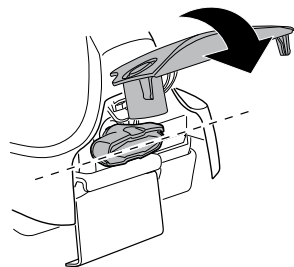

8



x1  
17 mm

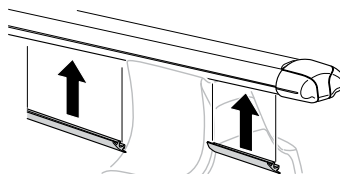
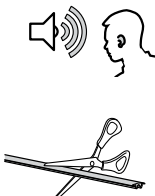

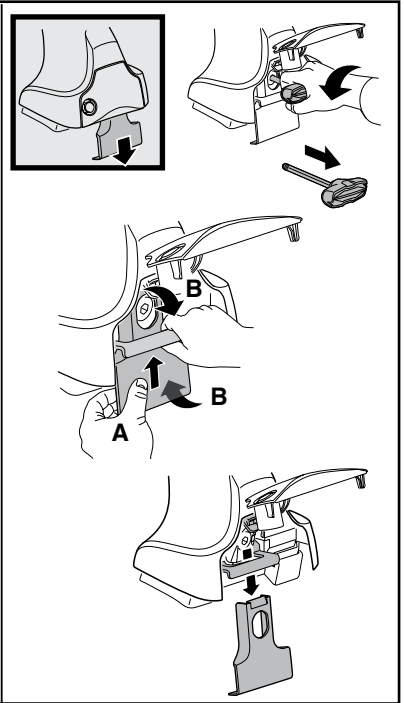
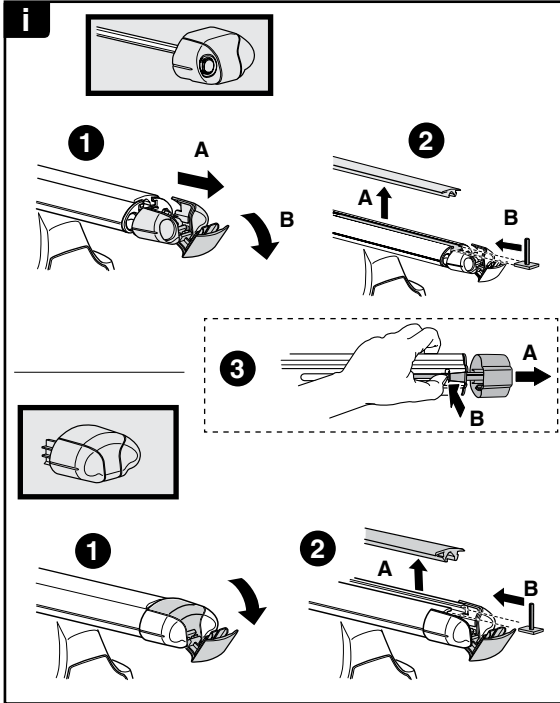

**THULE**  
SWEDEN  
**ONE  
KEY  
SYSTEM**



- 544** (x4)
  - 596** (x6)
  - 588** (x8)
  - 510** (x10)
  - 452** (x12)
- NA  
EUR  
ASIA

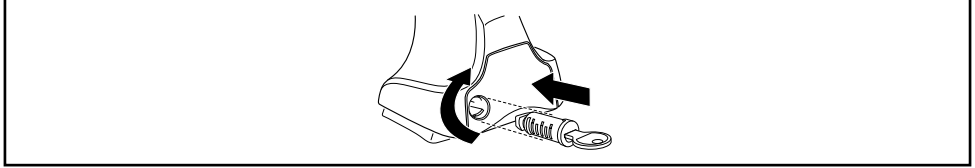

WW ▶ Thule Sweden AB, Box 69, 330 33 Hillerstorp, SWEDEN  
NA ▶ Thule Inc., 42 Silvermine Road, Seymour, Connecticut 06483, USA

info@thule.com  
customer.service@thule.com

www.thule.com