

# Kit 1580

NISSAN Altima, 4-dr Sedan, \*02-

\*North America

480R  
754

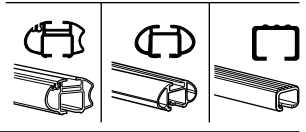
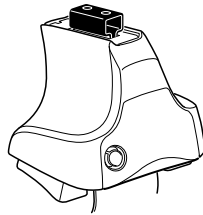

480

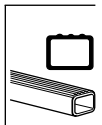
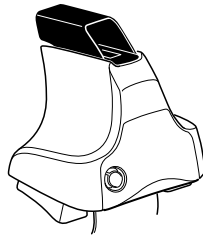

750

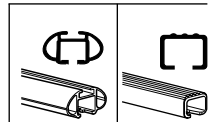
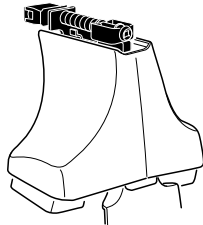

**Max.  
40 kg**  
**Max.  
88 lbs**

**+**

x1

x4

x4

x4  
 x4

**480R/754**

---

x1

x4

x4

x4

**480**

---

x1

x4

x4

**750**

x2 x2 x2 x4	x2	x2 x2 x4 x4	x2 x2	x2	x2

**539** x4

**271** x4

**x1**

**Kit**



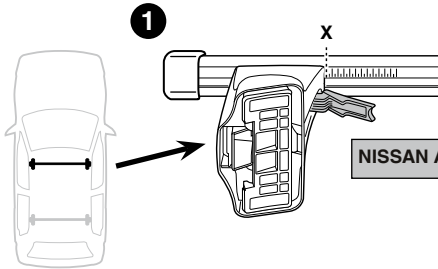

	X
NISSAN Altima, 4-dr Sedan, *02-	34

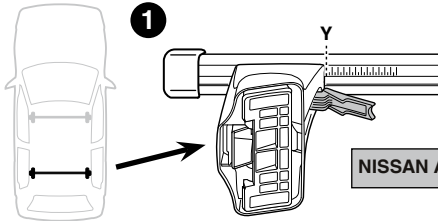

	Y
NISSAN Altima, 4-dr Sedan, *02-	31,5

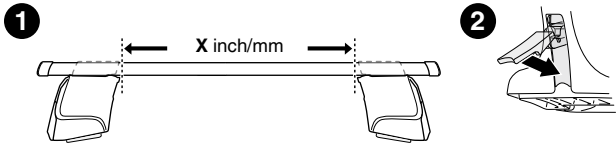
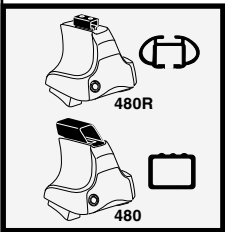

	X inch	X mm
NISSAN Altima, 4-dr Sedan, *02-	39"	991 mm

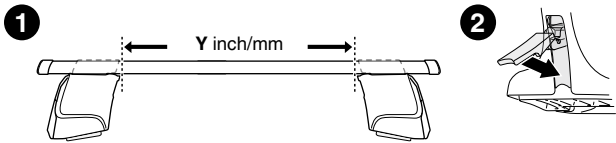
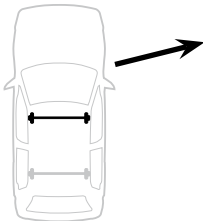

	Y inch	Y mm
NISSAN Altima, 4-dr Sedan, *02-	38 1/8"	968 mm

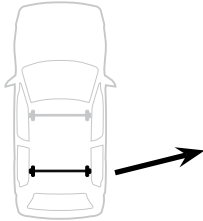

# 4

NISSAN Altima, 4-dr Sedan, \*02-

271



539



271



539

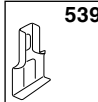

271



539



271



539

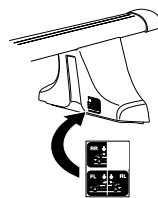
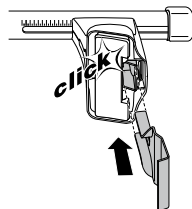
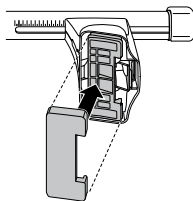
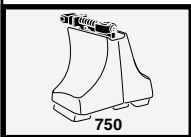
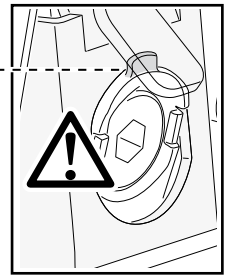
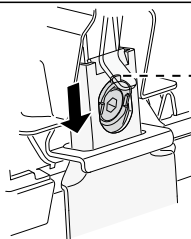
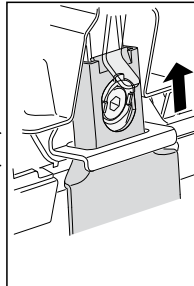
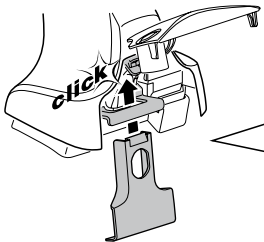
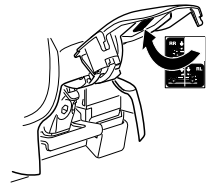
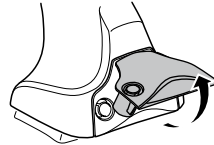
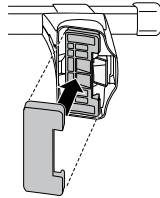
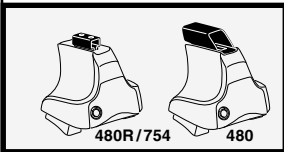
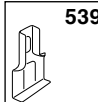

5



	X mm	Y mm	X inch	Y inch
NISSAN Altima, 4-dr Sedan, *02-	255 mm	710 mm	10"	28"

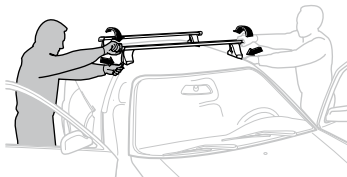
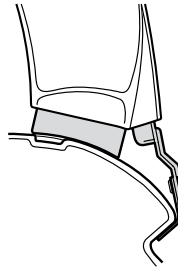
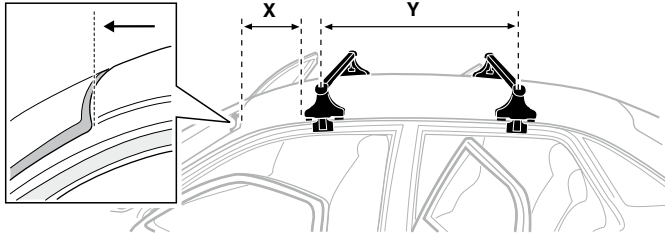

**GB/US** Tighten alternately

**D** Die Schrauben abwechselnd anziehen

**F** Serrer alternativement chaque côté

**NL** Afwisselend aan de linker- en de rechterkant aandraaien

**I** Alternare il serraggio delle viti

**E** Apretar alternativamente

**PT** Aperte alternadamente

**S** Dra åt växelvis

**FIN** Kierrä vuorotellen

**EST** Pinguldage vaheldumisi

**LAT** Pielieciet pamišus

**LIT** Užsukinėkite pakaitomis

**PL** Śruby dokręcaj naprzemiennie

**RU** Затягивайте попеременно

**CZ** Pokręťta bagažníka dokręcaj dokręcaj naprzemiennie.

**SK** Doťahujte striedavo

**SLO** Privijajte izmenično.

**HR** Naizmjenično zategnite

**HU** Egymástól függetlenül szorítandó

**GR** Σφιγγετε εναλλάξ

**TR** Dönüşümlü sıkın

**中文** 交替拧紧

**한국어** 번갈아 가며 조이십시오.

**日本語** 交互に締め付けてください。

**ไทย** ชันโนแบบสลับ

6



480R/754



480



\*  
3 Nm



\*

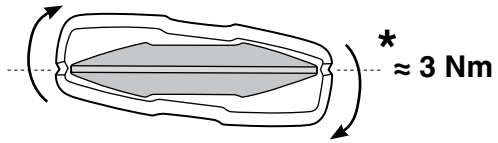

\*  
≈ 3 Nm

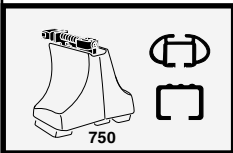

750

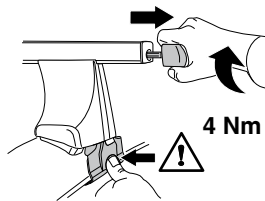

4 Nm

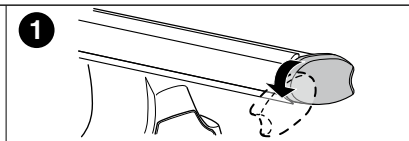
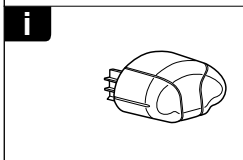
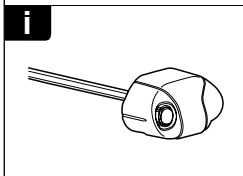
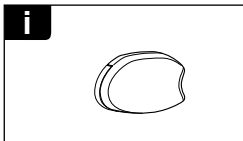
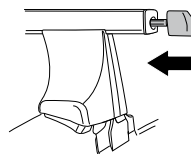

1

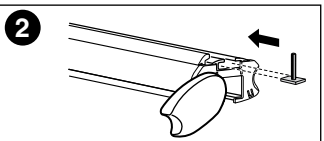

2

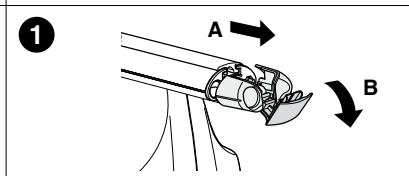

1

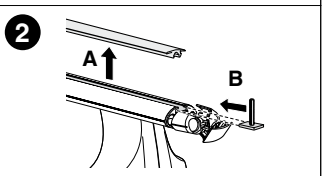

2

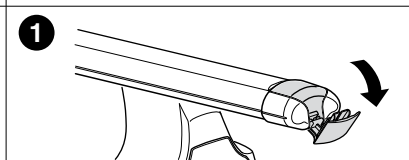

1

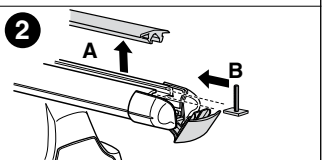

2

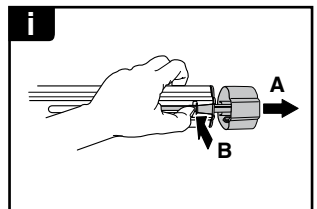
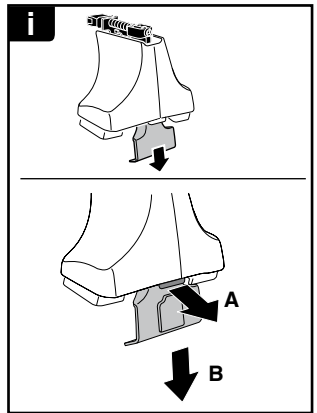
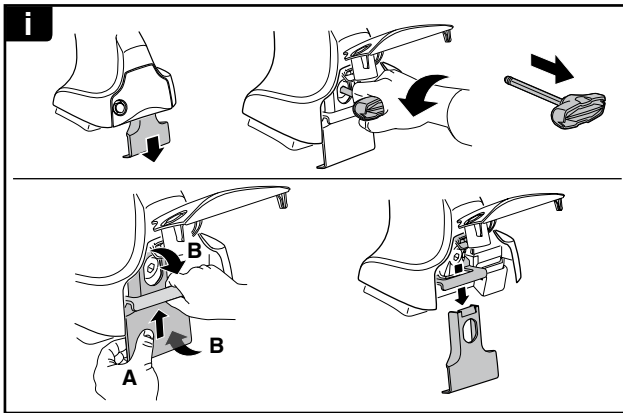
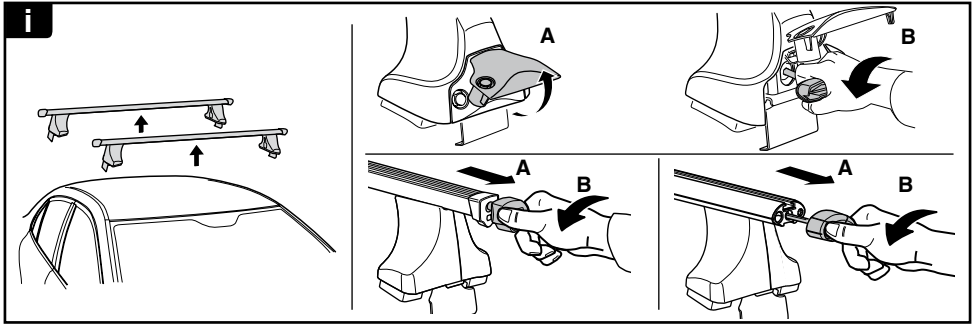

**THULE**  
SWEDEN  
**ONE  
KEY  
SYSTEM**



- 544 (x4)
- 596 (x6)
- 588 (x8)
- NA 510 (x10)
- EUR 452 (x12)
- ASIA

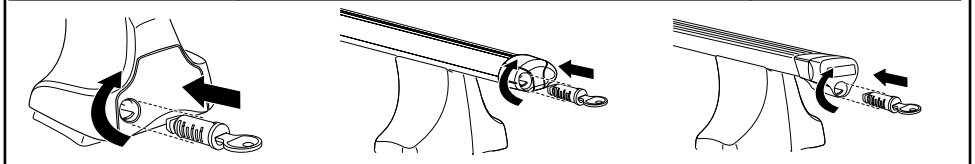

ww ▶ Thule Sweden AB, Box 69, 330 33 Hillerstorp, SWEDEN  
NA ▶ Thule Inc., 42 Silvermine Road, Seymour, Connecticut 06483, USA

info@thule.com  
customer.service@thule.com

www.thule.com