

# Kit 1468

**TOYOTA Ist (Mk.II), 5-dr Hatchback, 07–**  
**TOYOTA Urban Cruiser, 5-dr Hatchback, 09–**  
**SCION xD, 5-dr Hatchback, 08–**

480R  
754

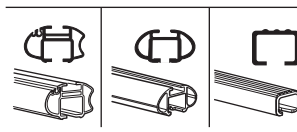
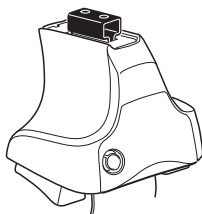

480

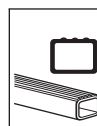
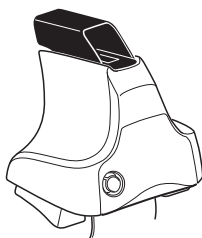

750

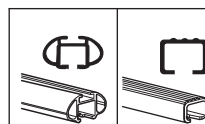
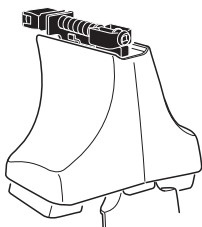

**THULE**<sup>®</sup>  
SWEDEN

**Kit**

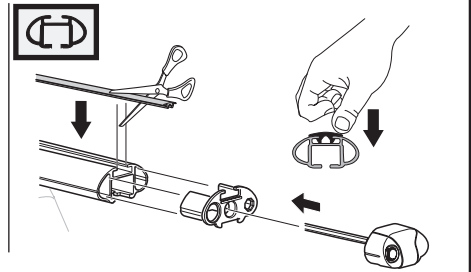
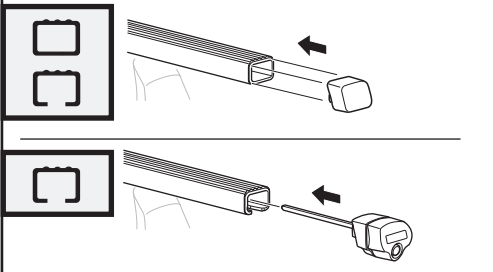
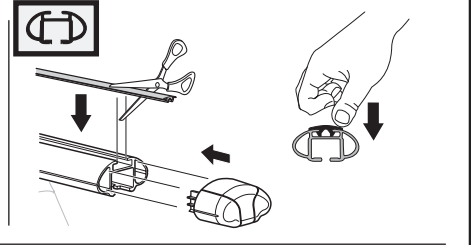
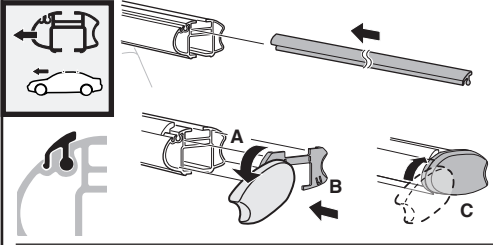
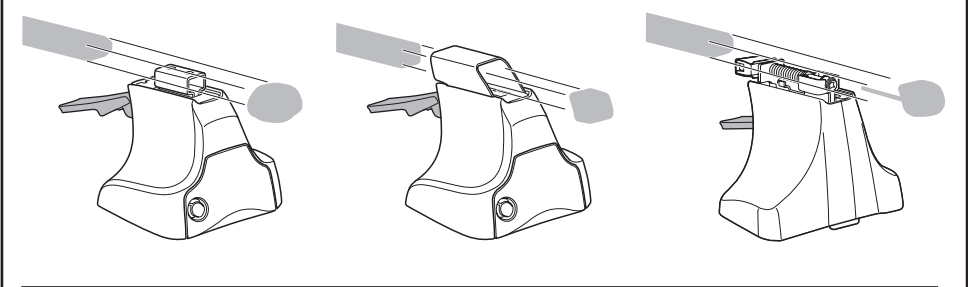
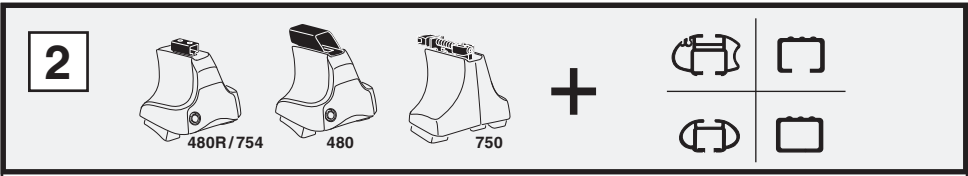
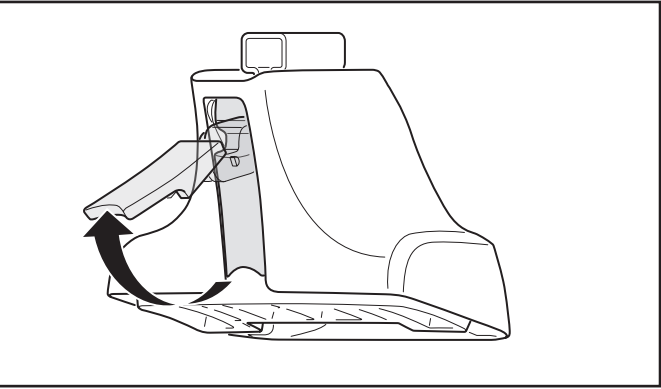
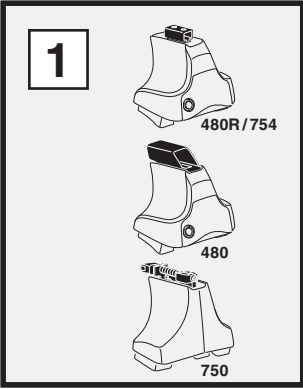

**3**

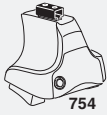

754

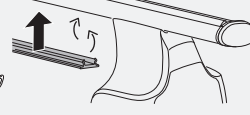
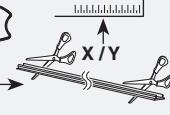

750



**1**

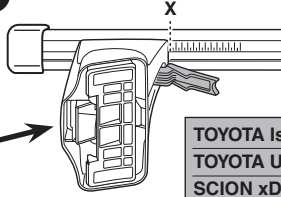
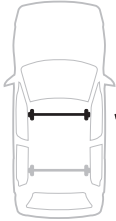

**2**

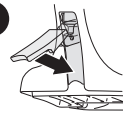

**X**

<b>TOYOTA Ist (Mk.II), 5-dr Hatchback, 07-</b>	<b>31,5</b>
<b>TOYOTA Urban Cruiser, 5-dr Hatchback, 09-</b>	<b>31,5</b>
<b>SCION xD, 5-dr Hatchback, 08-</b>	<b>31,5</b>

**1**

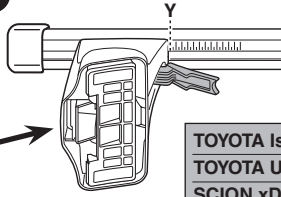

**2**

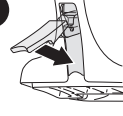

**Y**

<b>TOYOTA Ist (Mk.II), 5-dr Hatchback, 07-</b>	<b>28</b>
<b>TOYOTA Urban Cruiser, 5-dr Hatchback, 09-</b>	<b>28</b>
<b>SCION xD, 5-dr Hatchback, 08-</b>	<b>28</b>



480R



480

**1**

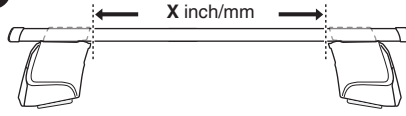

**2**

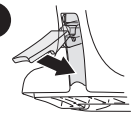

**X inch    X mm**

<b>TOYOTA Ist (Mk.II), 5-dr Hatchback, 07-</b>	<b>38"</b>	<b>966 mm</b>
<b>TOYOTA Urban Cruiser, 5-dr Hatchback, 09-</b>	<b>38"</b>	<b>966 mm</b>
<b>SCION xD, 5-dr Hatchback, 08-</b>	<b>38"</b>	<b>966 mm</b>

**1**

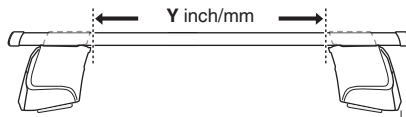

**2**

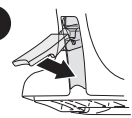

**Y inch    Y mm**

<b>TOYOTA Ist (Mk.II), 5-dr Hatchback, 07-</b>	<b>36 <sup>5</sup>/<sub>8</sub>"</b>	<b>931 mm</b>
<b>TOYOTA Urban Cruiser, 5-dr Hatchback, 09-</b>	<b>36 <sup>5</sup>/<sub>8</sub>"</b>	<b>931 mm</b>
<b>SCION xD, 5-dr Hatchback, 08-</b>	<b>36 <sup>5</sup>/<sub>8</sub>"</b>	<b>931 mm</b>

4

TOYOTA Ist (Mk.II), 5-dr Hatchback, 07–  
TOYOTA Urban Cruiser, 5-dr Hatchback, 09–  
SCION xD, 5-dr Hatchback, 08–

204



944



206



944



172



943



172



943

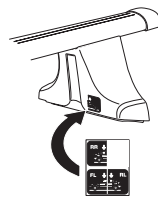
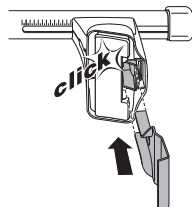
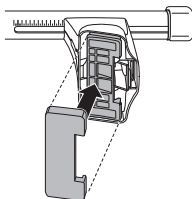
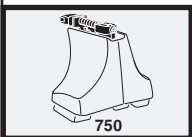
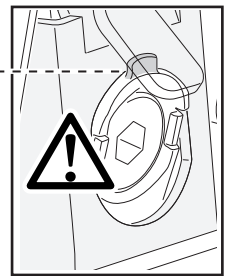
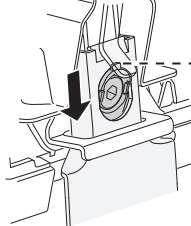
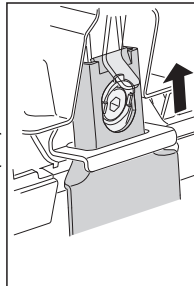
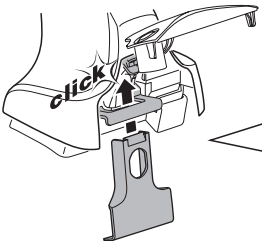
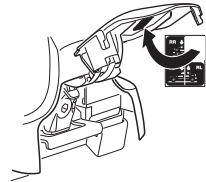
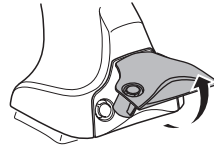
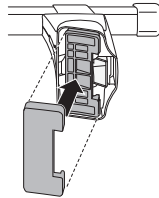
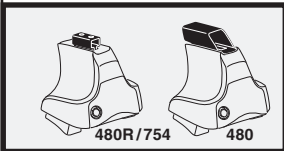

5

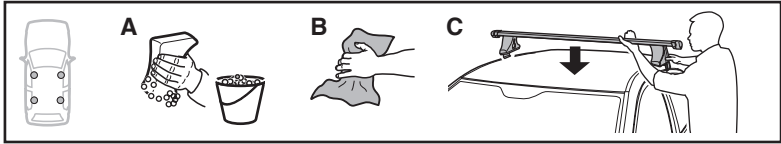

	X mm	Y mm	X inch	Y inch
TOYOTA Ist (Mk.II), 5-dr Hatchback, 07-	170 mm	715 mm	6 <sup>3</sup> / <sub>4</sub> "	28 <sup>1</sup> / <sub>8</sub> "
TOYOTA Urban Cruiser, 5-dr Hatchback, 09-	170 mm	715 mm	6 <sup>3</sup> / <sub>4</sub> "	28 <sup>1</sup> / <sub>8</sub> "
SCION xD, 5-dr Hatchback, 08-	170 mm	715 mm	6 <sup>3</sup> / <sub>4</sub> "	28 <sup>1</sup> / <sub>8</sub> "

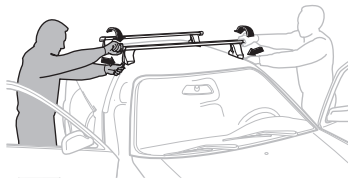
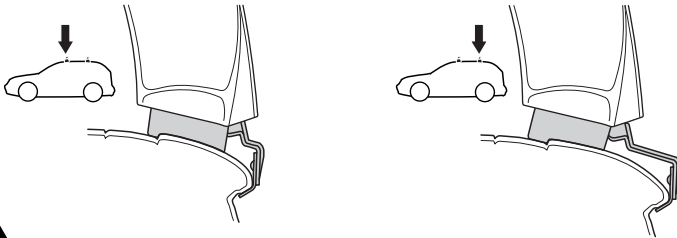
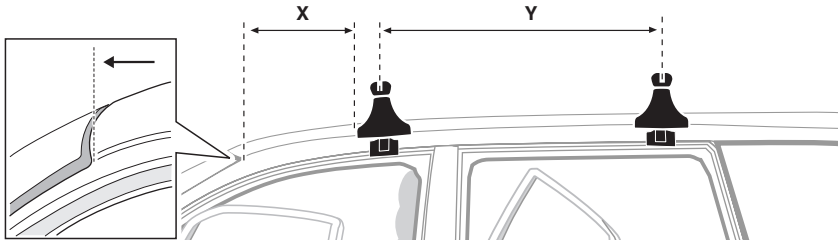

**GB/US** Tighten alternately

**D** Die Schrauben abwechselnd anziehen

**F** Serrer alternativement chaque côté

**NL** Afwisselend aan de linker- en de rechterkant aandraaien

**I** Alternare il serraggio delle viti

**E** Serrare alternativamente

**PT** Aperte alternadamente

**S** Dra åt växelvis

**FIN** Kierrä vuorotellen

**EST** Pinguldage vaheldumisi

**LAT** Pieveļciet pamišus

**LIT** Užsukinėkite pakaitomis

**PL** Śruby dokręcaj naprzemiennie

**RU** Затягивайте попеременно

**CZ** Pokręťta bagażníka dokręcaj dokręcaj naprzemiennie.

**SK** Doťahujte striedavo

**SLO** Privijajte izmenično.

**HR** Naizmjenično zategnite

**HU** Egymástól függetlenül szorítandó

**GR** Σφιγγετε εναλλάξ

**TR** Dönüşümlü sıkın

**中文** 交替拧紧

**한국어** 번갈아 가며 조이십시오.

**日本語** 交互に締め付けてください。

**ไทย** ชั้นโนแบบสลับ

6



480R/754



480

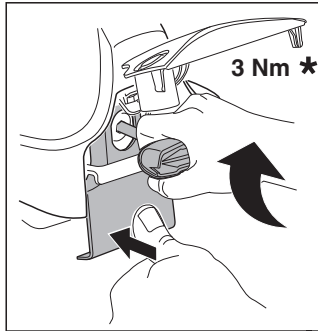
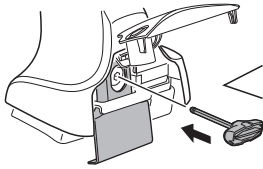

3 Nm \*

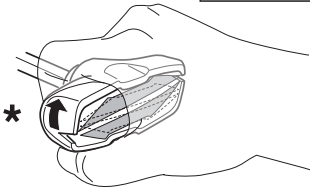
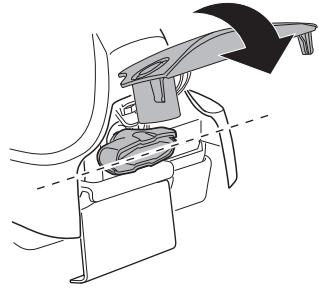

\*

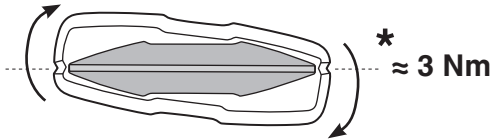

\* ≈ 3 Nm



750

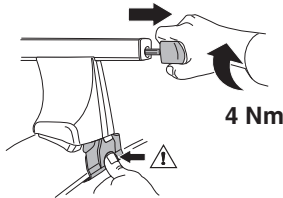

4 Nm

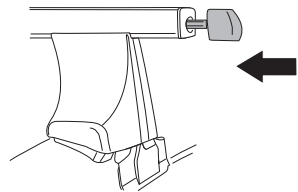

i



1



2

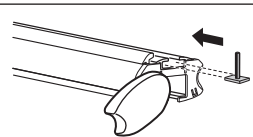

i

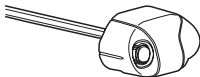

1

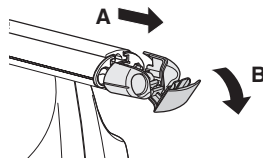

2

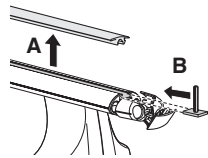

i



1

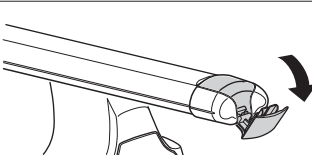

2

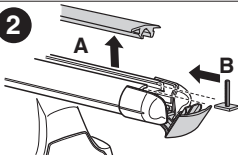

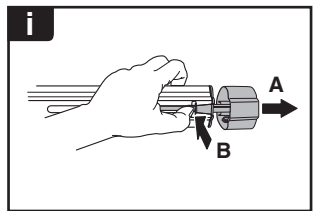
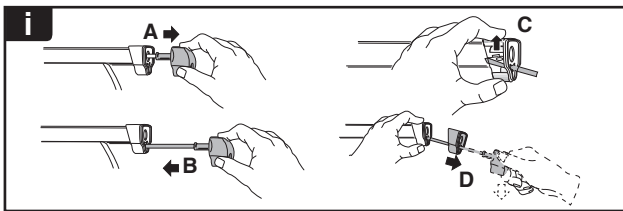
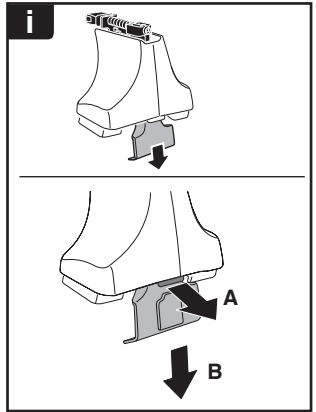
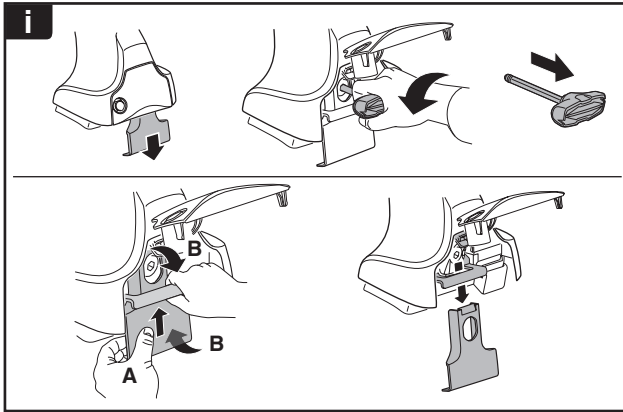
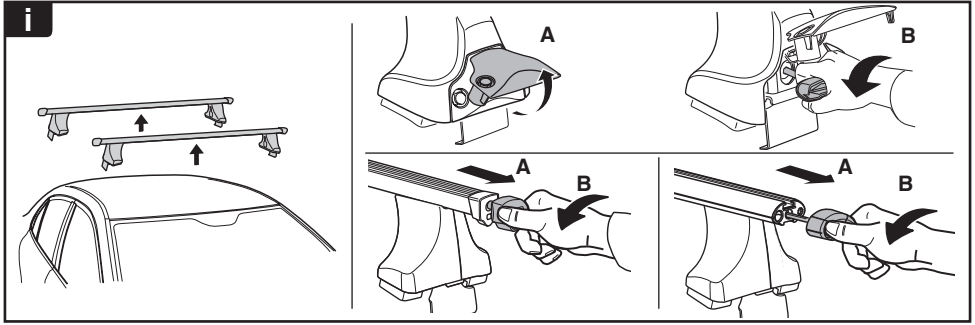

**THULE**  
SWEDEN  
**ONE  
KEY  
SYSTEM**

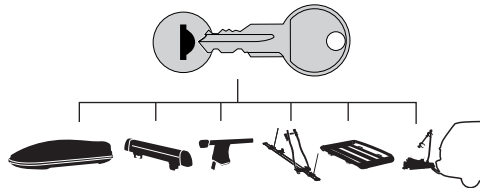

		(x4)
		(x6)
		(x8)
NA		(x10)
EUR		(x12)
ASIA		(x12)

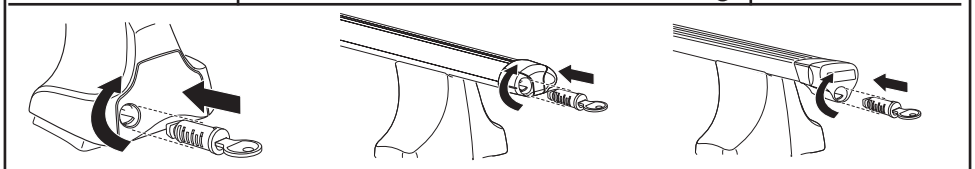

WW ▶ Thule Sweden AB, Box 69, 330 33 Hillerstorp, SWEDEN  
NA ▶ Thule Inc., 42 Silvermine Road, Seymour, Connecticut 06483, USA

info@thule.com  
customer.service@thule.com

www.thule.com