

Kit 1461

CHEVROLET Colorado, 4-dr Double Cab, 04–
CHEVROLET Colorado, 4-dr Extended Cab, 04–
ISUZU D-max, 4-dr Double Cab, 02–
ISUZU D-max, 4-dr Extended Cab, 02–

480R
754

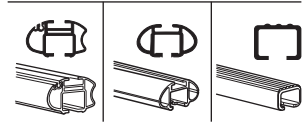
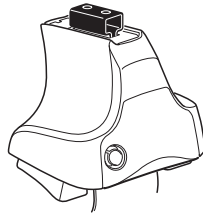

480

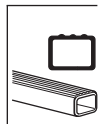
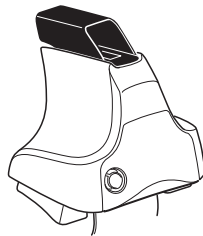

750

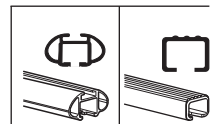
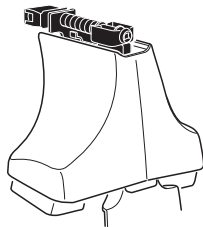

Kit

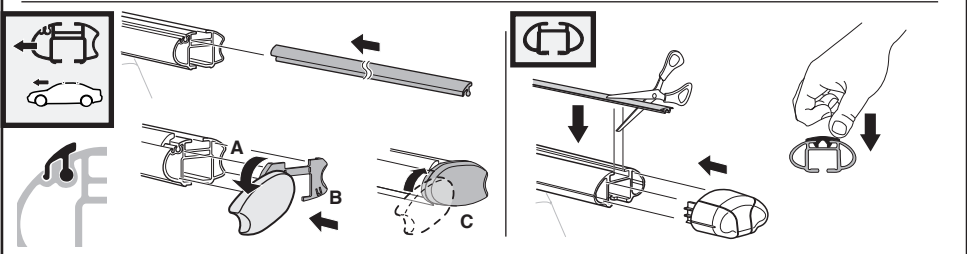
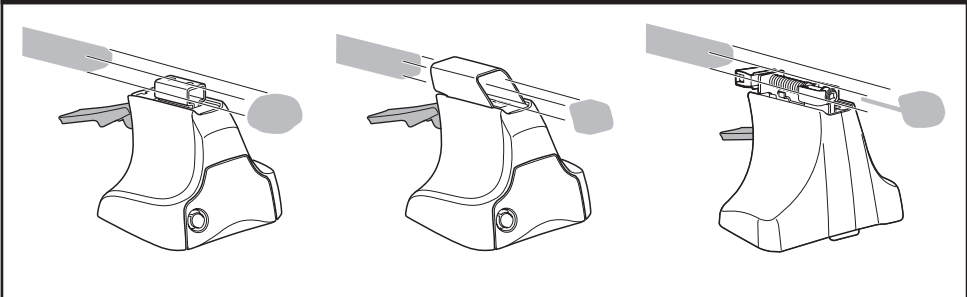

3

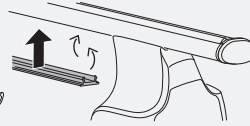
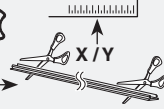
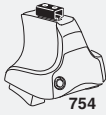

1

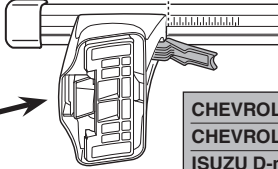
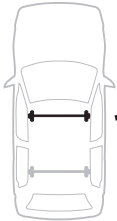

2

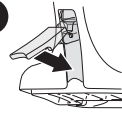

	X
CHEVROLET Colorado, 4-dr Double Cab, 04-	34
CHEVROLET Colorado, 4-dr Extended Cab, 04-	34
ISUZU D-max, 4-dr Double Cab, 02-	34
ISUZU D-max, 4-dr Extended Cab, 02-	34

1

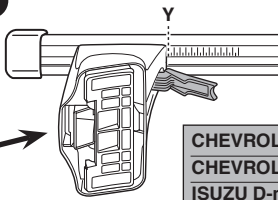
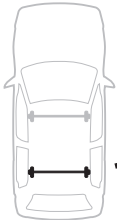

2

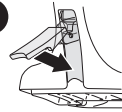

	Y
CHEVROLET Colorado, 4-dr Double Cab, 04-	32
CHEVROLET Colorado, 4-dr Extended Cab, 04-	32
ISUZU D-max, 4-dr Double Cab, 02-	32
ISUZU D-max, 4-dr Extended Cab, 02-	32



480R



480

1

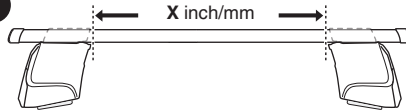

2

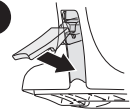

	X inch	X mm
CHEVROLET Colorado, 4-dr Double Cab, 04-	39"	991 mm
CHEVROLET Colorado, 4-dr Extended Cab, 04-	39"	991 mm
ISUZU D-max, 4-dr Double Cab, 02-	39"	991 mm
ISUZU D-max, 4-dr Extended Cab, 02-	39"	991 mm

1

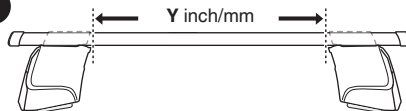

2

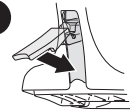

	Y inch	Y mm
CHEVROLET Colorado, 4-dr Double Cab, 04-	38 1/4"	971 mm
CHEVROLET Colorado, 4-dr Extended Cab, 04-	38 1/4"	971 mm
ISUZU D-max, 4-dr Double Cab, 02-	38 1/4"	971 mm
ISUZU D-max, 4-dr Extended Cab, 02-	38 1/4"	971 mm

4

CHEVROLET Colorado, 4-dr Double Cab, 04–
CHEVROLET Colorado, 4-dr Extended Cab, 04–
ISUZU D-max, 4-dr Double Cab, 02–
ISUZU D-max, 4-dr Extended Cab, 02–

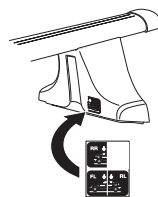
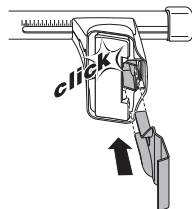
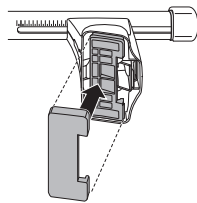
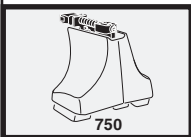
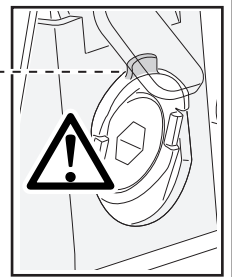
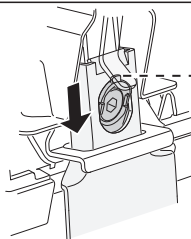
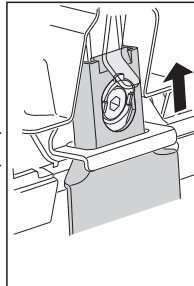
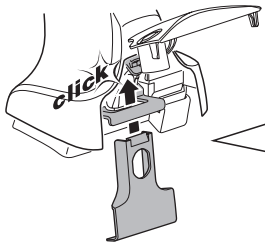
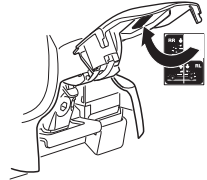
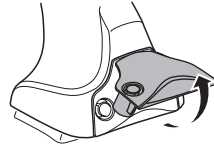
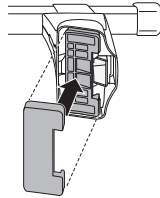
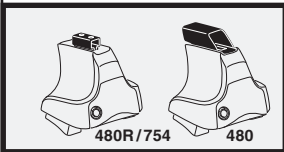
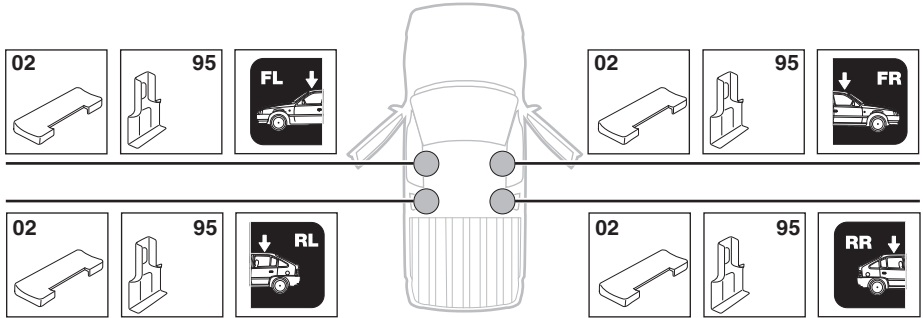

5

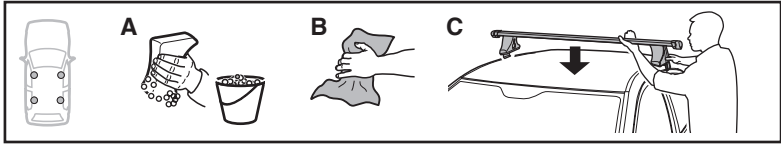

	X mm	Y mm	X inch	Y inch
CHEVROLET Colorado, 4-dr Double Cab, 04-	380 mm	750 mm	15"	29 1/2"
CHEVROLET Colorado, 4-dr Extended Cab, 04-	250 mm	680 mm	9 7/8"	26 3/4"
ISUZU D-max, 4-dr Double Cab, 02-	380 mm	750 mm	15"	29 1/2"
ISUZU D-max, 4-dr Extended Cab, 02-	250 mm	680 mm	9 7/8"	26 3/4"

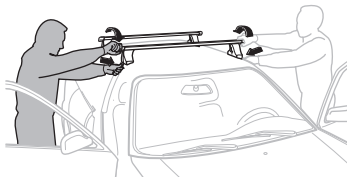
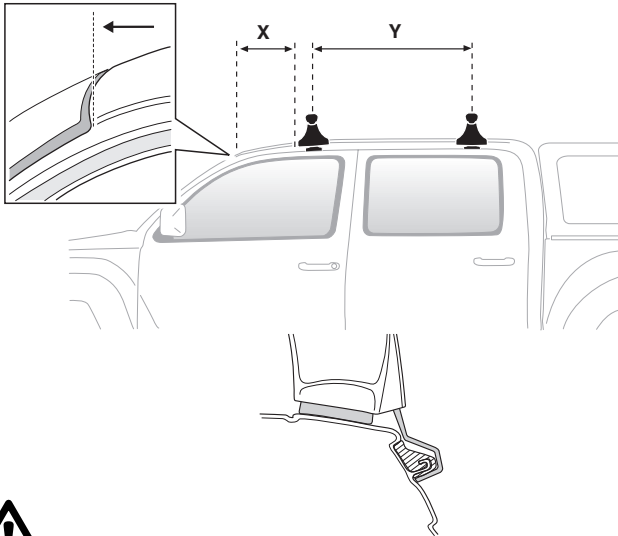

GB/US Tighten alternately

D Die Schrauben abwechselnd anziehen

F Serrer alternativement chaque côté

NL Afwisselend aan de linker- en de rechterkant aandraaien

I Alternare il serraggio delle viti

E Serrare alternativamente

PT Aperte alternadamente

S Dra åt växelvis

FIN Kierrä vuorotellen

EST Pinguldage vaheldumisi

LAT Pieveļciēt pamišus

LIT Užsukinėkite pakaitomis

PL Śruby dokręcaj naprzemiennie

RU Затягивайте попеременно

CZ Pokręťta багаžníka dokręcaj dokręcaj naprzemiennie.

SK Doťahujte striedavo

SLO Privijajte izmenično.

HR Naizmjenično zategnite

HU Egymástól függetlenül szorítandó

GR Σφιγγετε εναλλάξ

TR Dönüşümlü sıkın

中文 交替拧紧

한국어 번갈아 가며 조이십시오.

日本語 交互に締め付けてください。

ไทย ชันโนแบบสลับ

6



480R/754



480

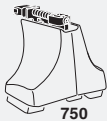
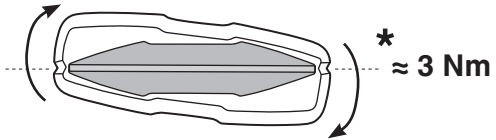
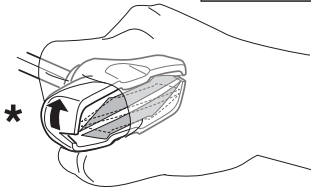
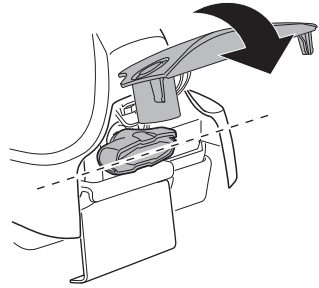
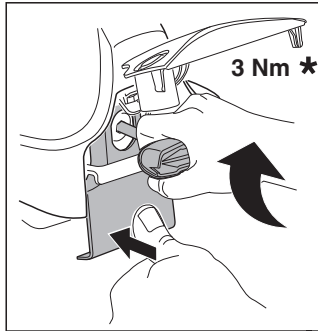
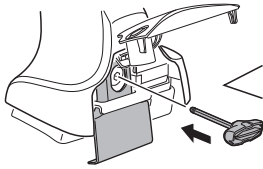

750

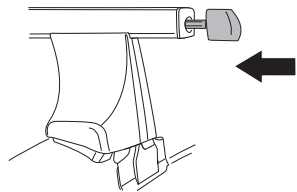
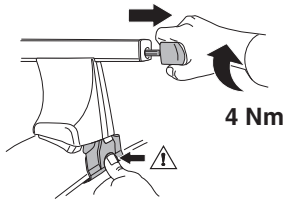

i



1



2

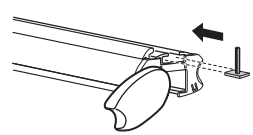

i

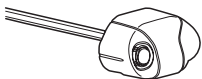

1

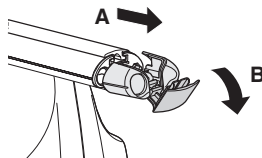

2

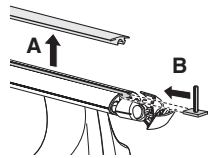

i



1

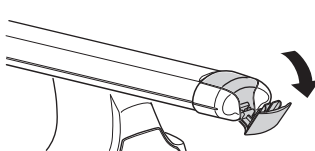

2

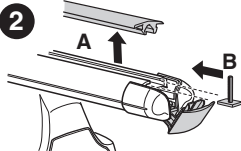

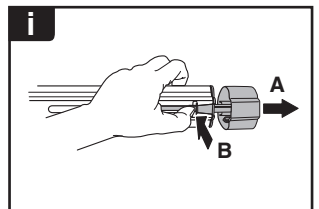
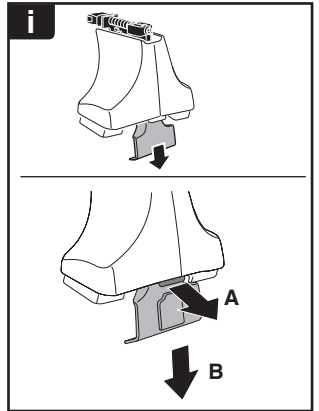
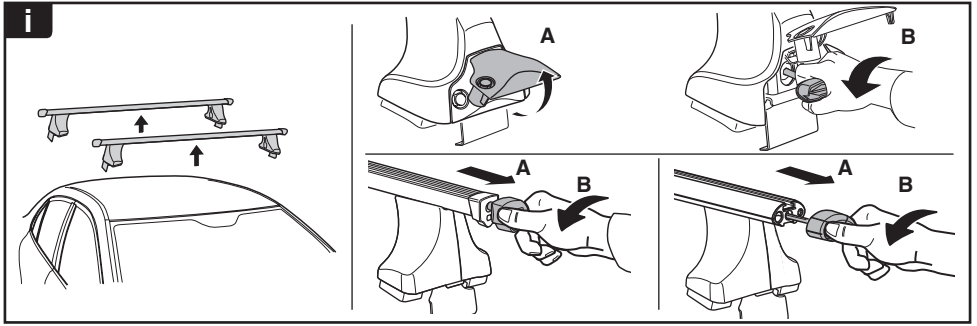

THULE
SWEDEN
**ONE
KEY
SYSTEM**



- 544** (x4)
 - 596** (x6)
 - 588** (x8)
 - 510** (x10)
 - 452** (x12)
- NA
EUR
ASIA

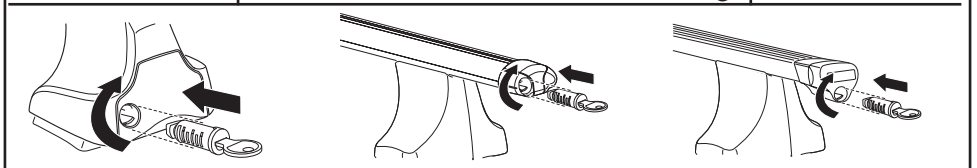

WW ▶ Thule Sweden AB, Box 69, 330 33 Hillerstorp, SWEDEN
NA ▶ Thule Inc., 42 Silvermine Road, Seymour, Connecticut 06483, USA

info@thule.com
customer.service@thule.com

www.thule.com