

Kit 1269

NISSAN Skyline, 4-dr Sedan, 02-06

INFINITI G35, 4-dr Sedan, *03-06

*North America

480R
754

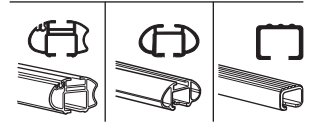
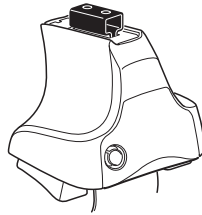

480

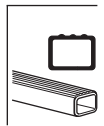
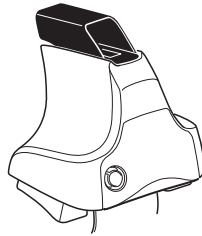

750

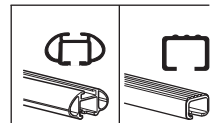
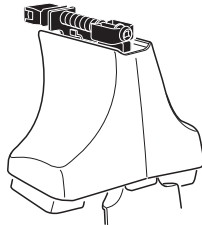

xx kg
 xx lbs + 7 kg
 15,4 lbs = **Max. 50 kg**
Max. 110 lbs

80 km/h 50 Mph
 130 km/h 80 Mph
 40 km/h 25 Mph
km/h Mph

THULE

instructions
 Kit XXXX

x1 x4 x4 x4

480R/754

x1 x4 x4 x4

480

x1 x4 x4

750

x2	x2	x2	x2	x2
x2		x2	x2	
x2		x2	x2	
x4		x4	x4	

451 x2
 452 x2
 07 x2
 23 x1
 24 x1

x1

Kit

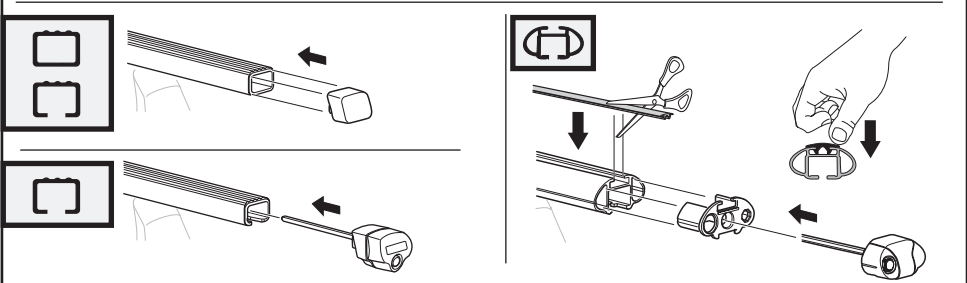
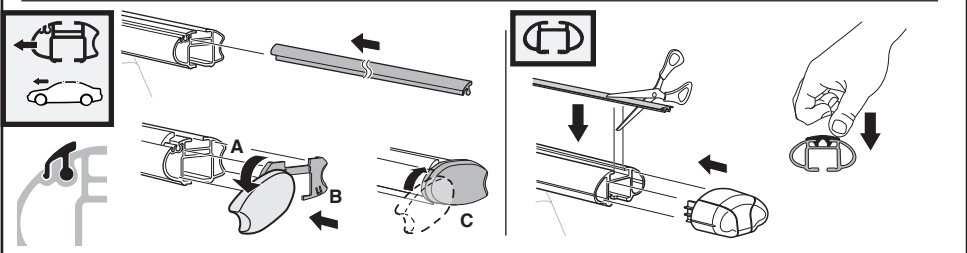
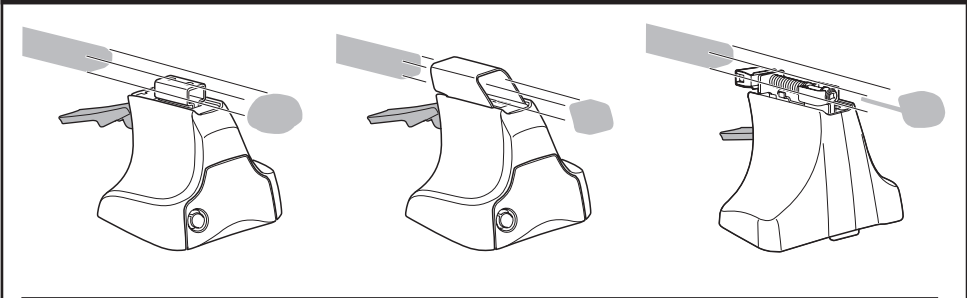
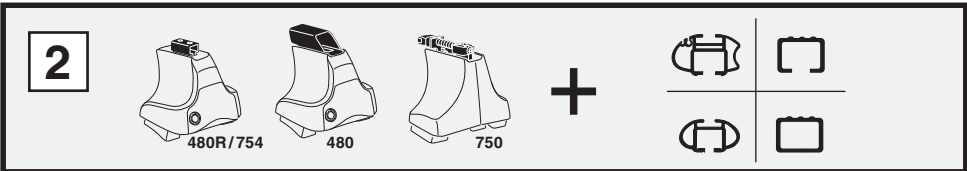
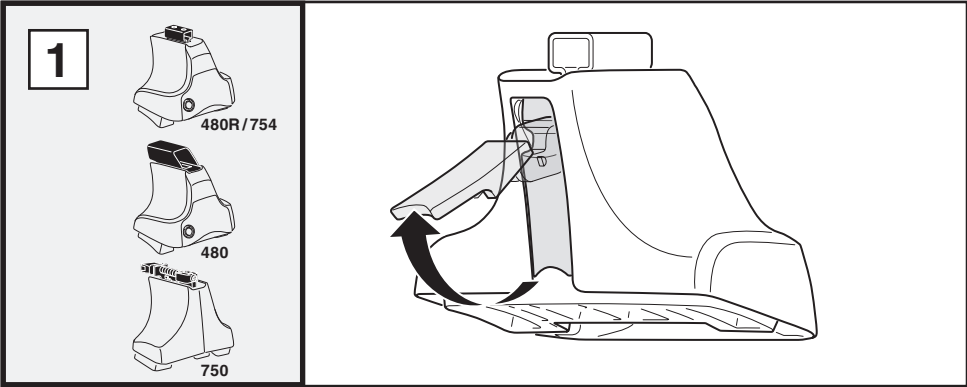

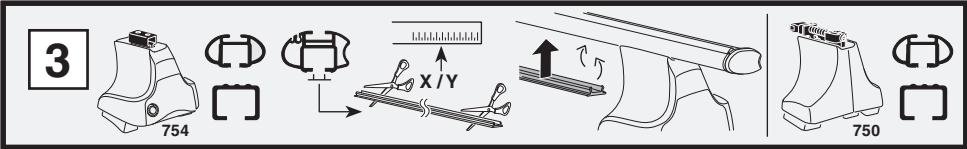

1

2

	X
NISSAN Skyline, 4-dr Sedan, 02-06	39,5
INFINITI G35, 4-dr Sedan, *03-06	39,5

1

2

	Y
NISSAN Skyline, 4-dr Sedan, 02-06	40,5
INFINITI G35, 4-dr Sedan, *03-06	40,5

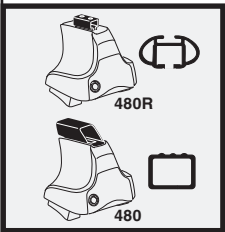

1

2

	X inch	X mm
NISSAN Skyline, 4-dr Sedan, 02-06	41 1/8"	1046 mm
INFINITI G35, 4-dr Sedan, *03-06	41 1/8"	1046 mm

1

2

	Y inch	Y mm
NISSAN Skyline, 4-dr Sedan, 02-06	41 5/8"	1056 mm
INFINITI G35, 4-dr Sedan, *03-06	41 5/8"	1056 mm

4

NISSAN Skyline, 4-dr Sedan, 02-06
INFINITI G35, 4-dr Sedan, *03-06

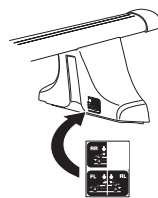
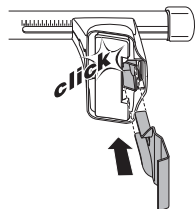
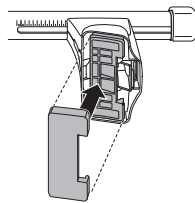
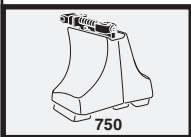
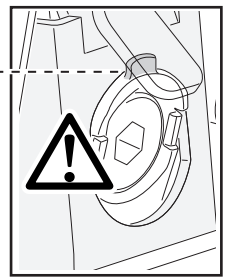
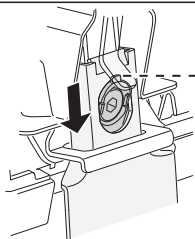
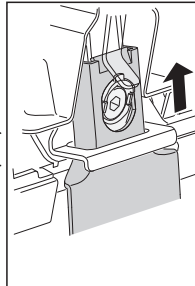
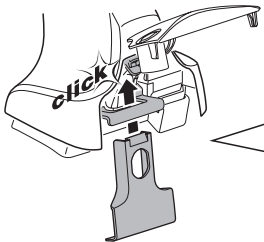
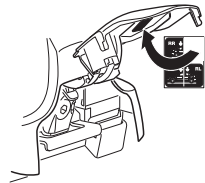
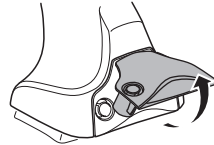
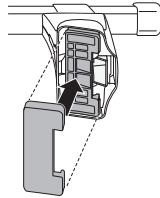
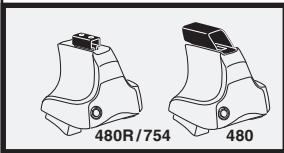
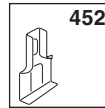
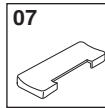
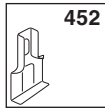
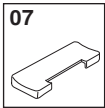
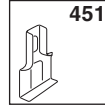
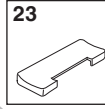
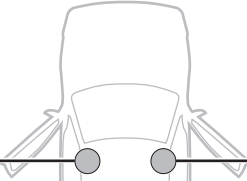
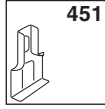
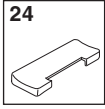

5

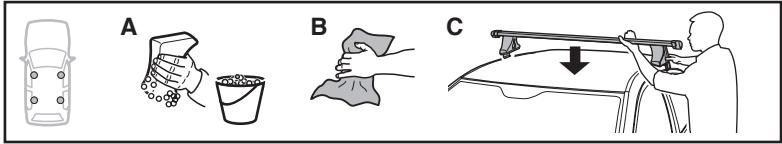

	X mm	Y mm	X inch	Y inch
NISSAN Skyline, 4-dr Sedan, 02-06	245 mm	700 mm	9 5/8"	27 1/2"
INFINITI G35, 4-dr Sedan, *03-06	245 mm	700 mm	9 5/8"	27 1/2"

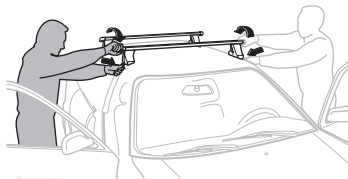
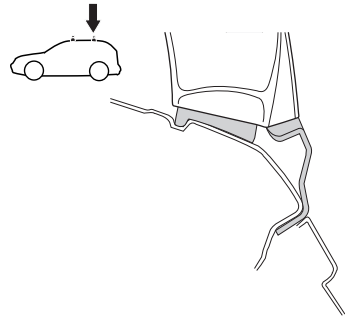
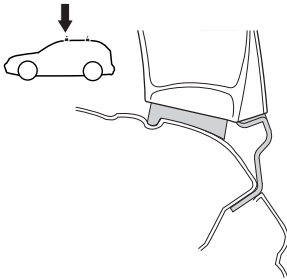
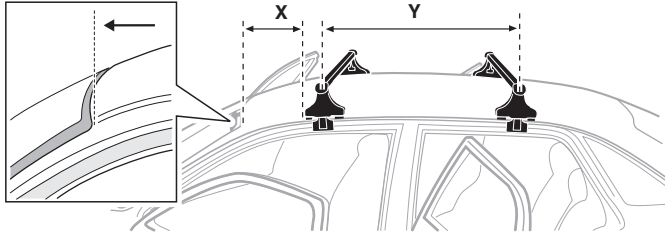

GB/US Tighten alternately

D Die Schrauben abwechselnd anziehen

F Serrer alternativement chaque côté

NL Afwisselend aan de linker- en de rechterkant aandraaien

I Alternare il serraggio delle viti

E Apretar alternativamente

PT Aperte alternadamente

S Dra åt växelvis

FIN Kierrä vuorotellen

EST Pinguldage vaheldumisi

LAT Pielieciet pamišus

LIT Užsukinėkite pakaitomis

PL Śruby dokręcaj naprzemiennie

RU Затягивайте попеременно

CZ Pokręťta bagażníka dokręcaj dokręcaj naprzemiennie.

SK Doťahujte striedavo

SLO Privijajte izmenično.

HR Naizmjenično zategnite

HU Egymástól függetlenül szorítandó

GR Σφίγγετε εναλλάξ

TR Dönüşümlü sıkın

中文 交替拧紧

한국어 번갈아 가며 조이십시오.

日本語 交互に締め付けてください。

ไทย ชั้้นโน้บแบบสลับ

6



480R/754



480

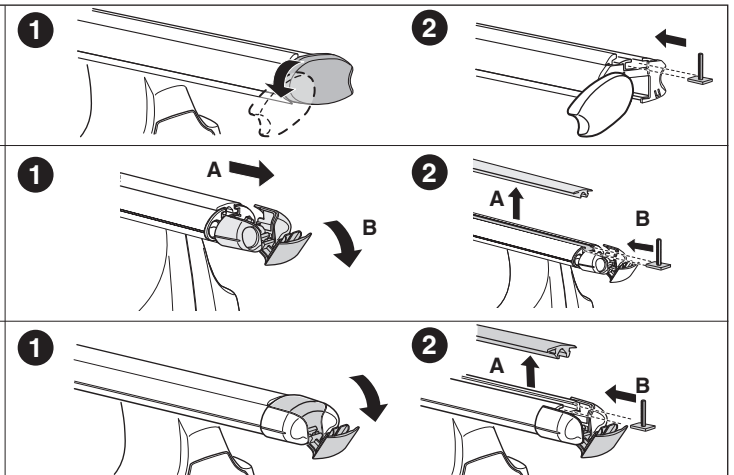
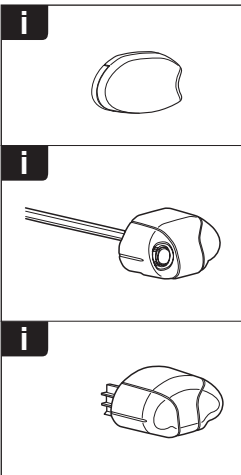
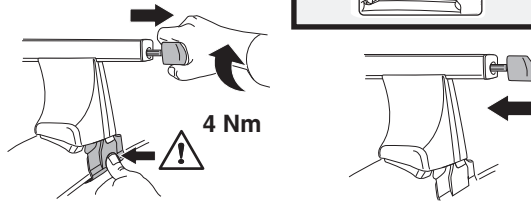
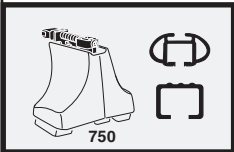
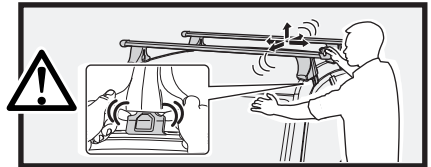
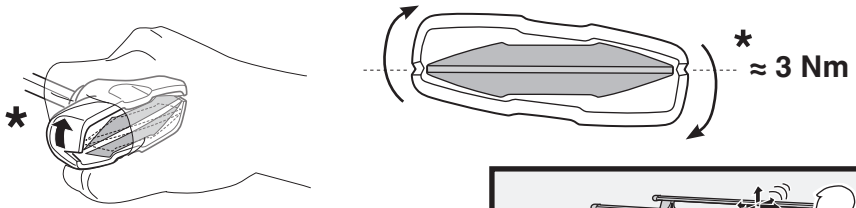
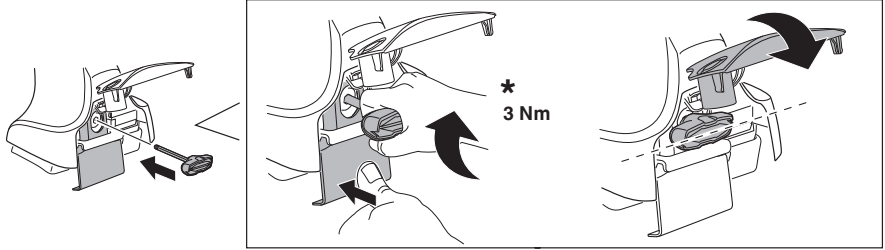

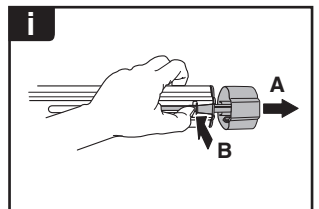
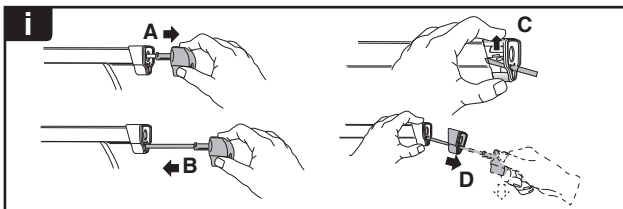
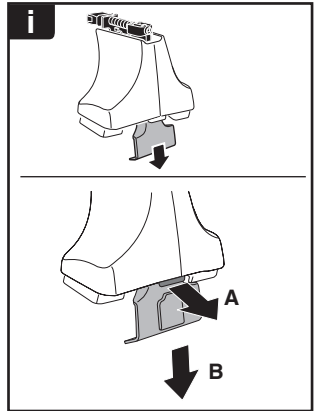
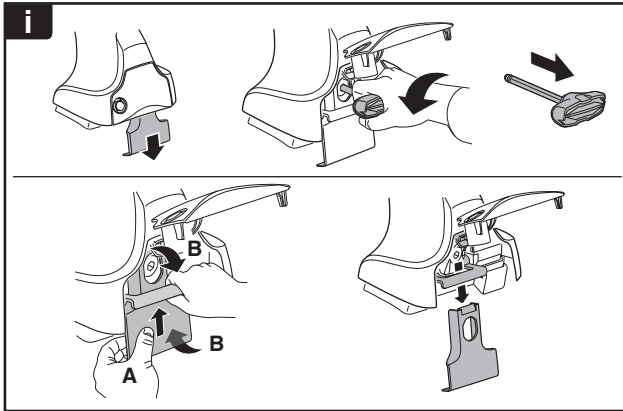
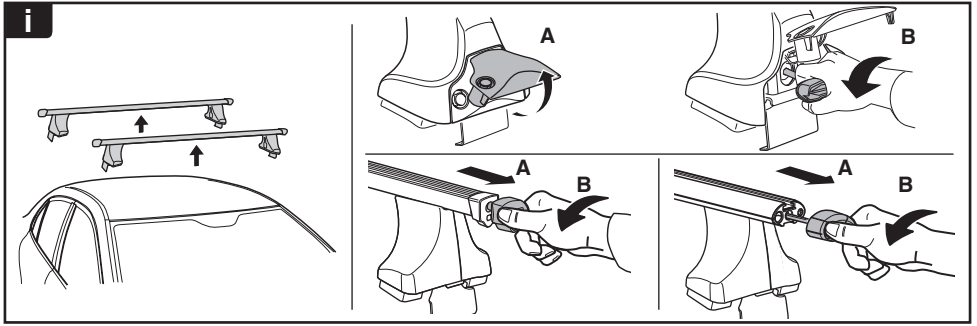

THULE
SWEDEN
**ONE
KEY
SYSTEM**

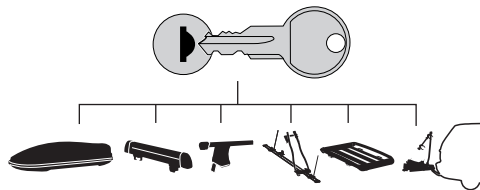

- 544 (x4)
- 596 (x6)
- 588 (x8)
- NA 510 (x10)
- EUR 452 (x12)
- ASIA

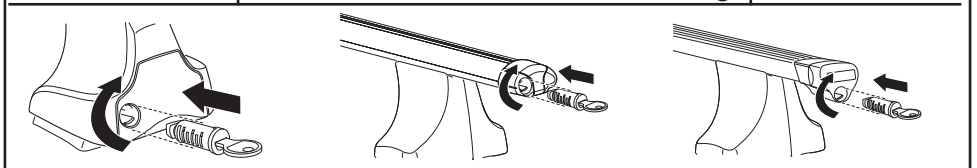

WW ▶ Thule Sweden AB, Box 69, 330 33 Hillerstorp, SWEDEN
NA ▶ Thule Inc., 42 Silvermine Road, Seymour, Connecticut 06483, USA

info@thule.com
customer.service@thule.com

www.thule.com