

# Kit 1261

DAIHATSU Altis, 4-dr Sedan, 01-06

TOYOTA Camry, 4-dr Sedan, 02-06

480R  
754

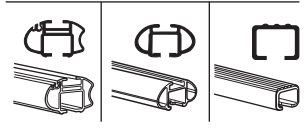
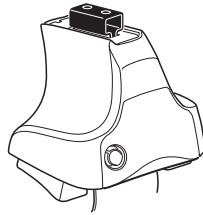

480

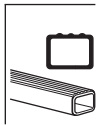
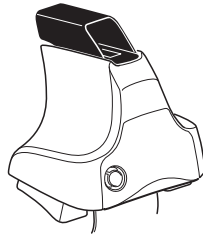

750

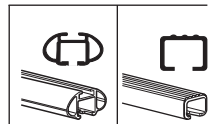
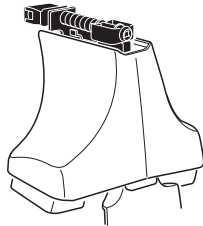

**Kit**

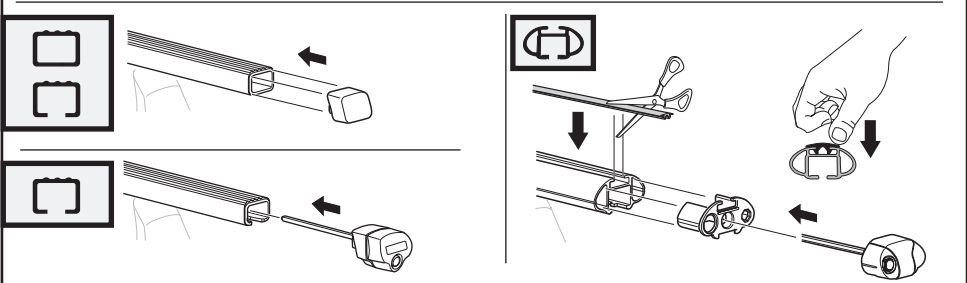
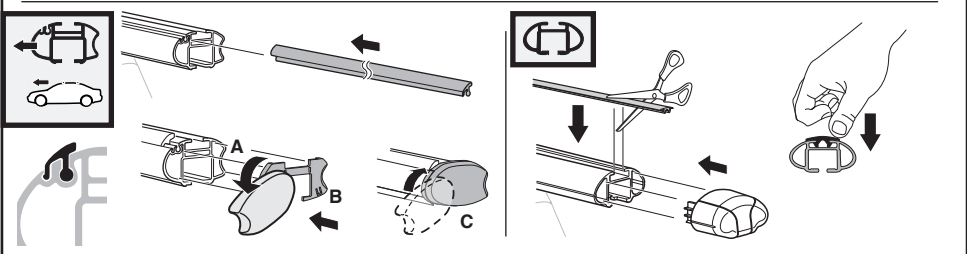
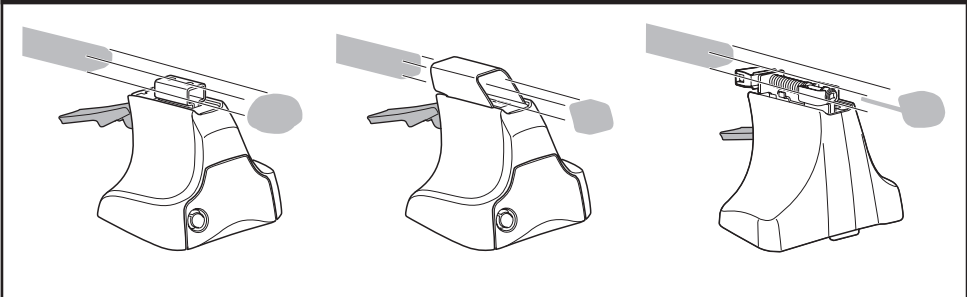
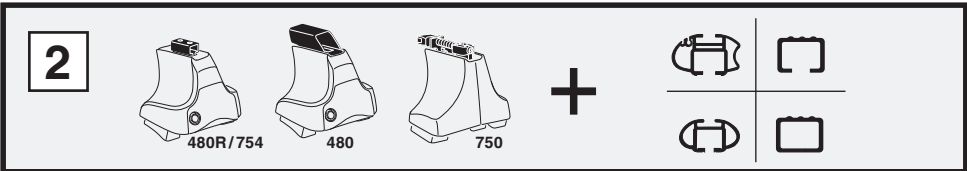
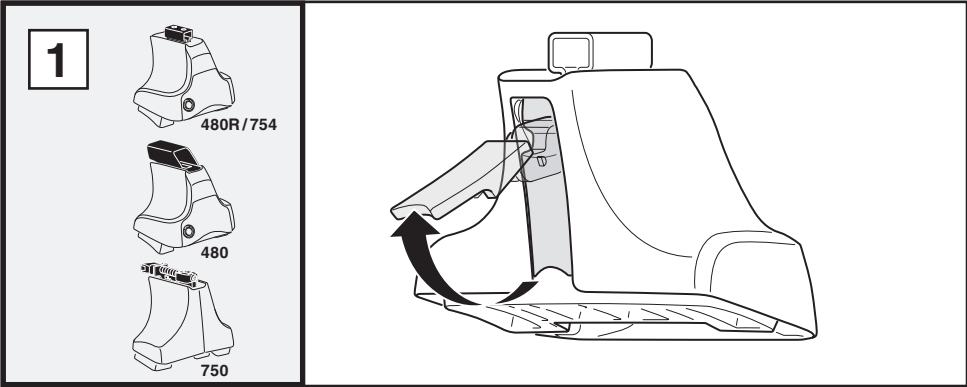

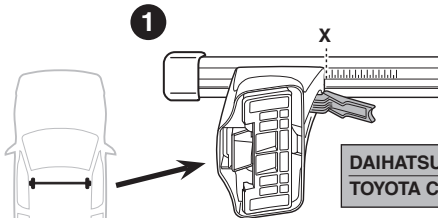
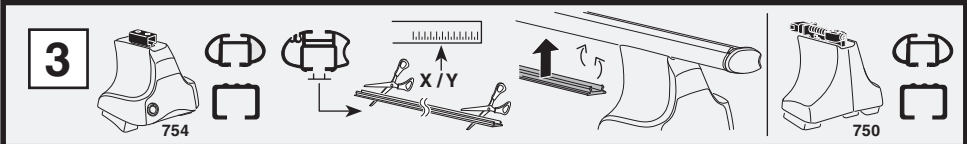

	X
DAIHATSU Altis, 4-dr Sedan, 01-06	41
TOYOTA Camry, 4-dr Sedan, 02-06	41

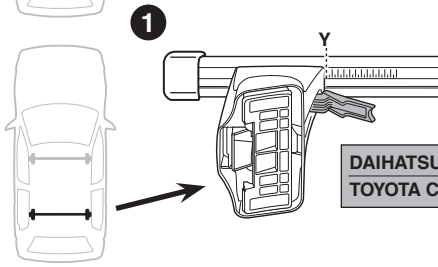

	Y
DAIHATSU Altis, 4-dr Sedan, 01-06	39
TOYOTA Camry, 4-dr Sedan, 02-06	39

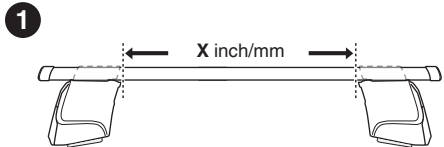
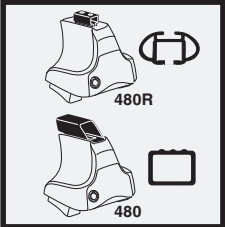

	X inch	X mm
DAIHATSU Altis, 4-dr Sedan, 01-06	41 <sup>3</sup> / <sub>4</sub> "	1061 mm
TOYOTA Camry, 4-dr Sedan, 02-06	41 <sup>3</sup> / <sub>4</sub> "	1061 mm

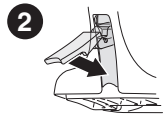
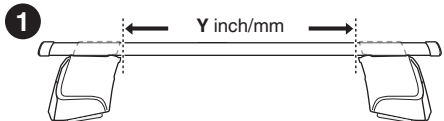

	Y inch	Y mm
DAIHATSU Altis, 4-dr Sedan, 01-06	41 "	1041 mm
TOYOTA Camry, 4-dr Sedan, 02-06	41 "	1041 mm

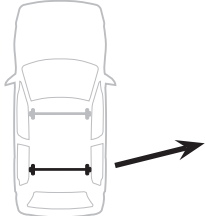

# 4

DAIHATSU Altis, 4-dr Sedan, 01-06  
TOYOTA Camry, 4-dr Sedan, 02-06

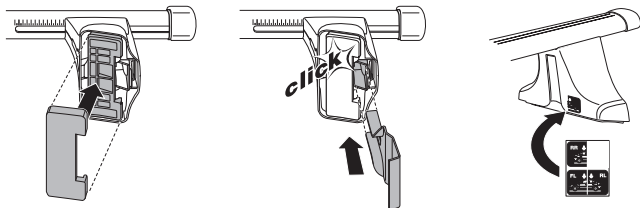
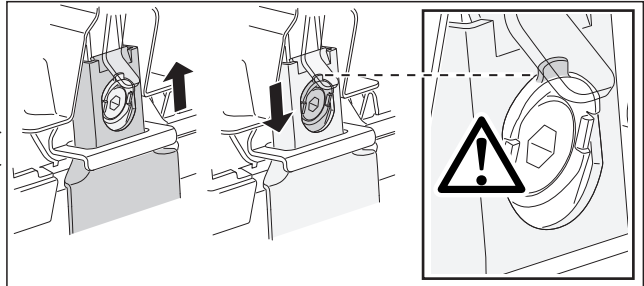
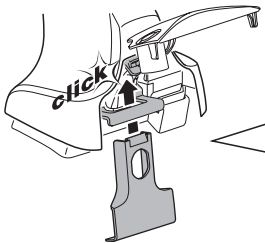
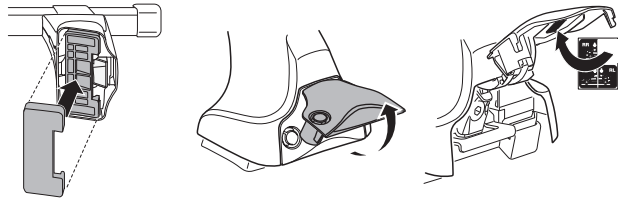
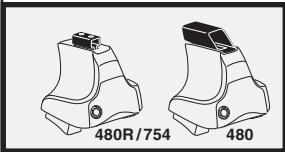
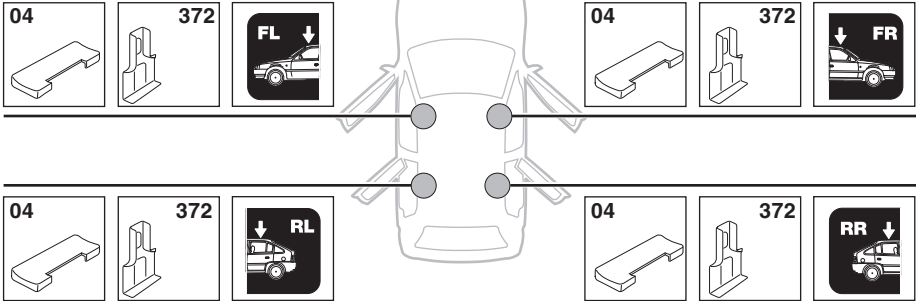

5

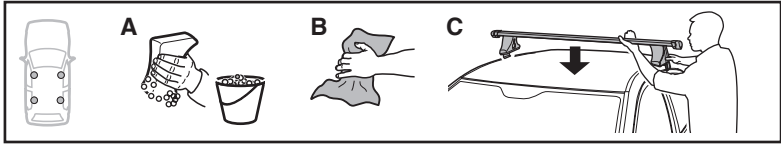

	X mm	Y mm	X inch	Y inch
DAIHATSU Altis, 4-dr Sedan, 01-06	240 mm	650 mm	9 1/4"	25 5/8"
TOYOTA Camry, 4-dr Sedan, 02-06	240 mm	650 mm	9 1/4"	25 5/8"

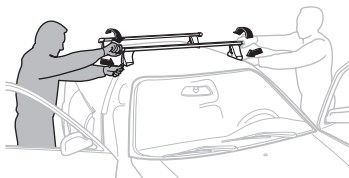
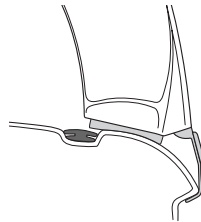
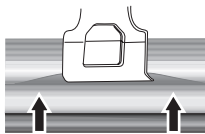
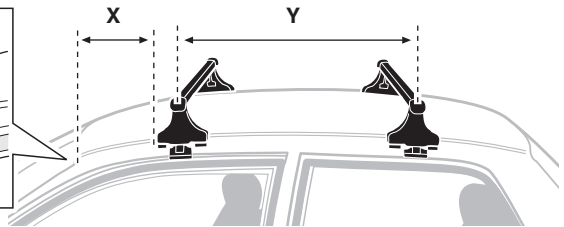
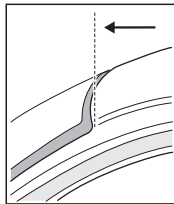

**GB/US** Tighten alternately

**D** Die Schrauben abwechselnd anziehen

**F** Serrer alternativement chaque côté

**NL** Afwisselend aan de linker- en de rechterkant aandraaien

**I** Alternare il serraggio delle viti

**E** Serrare alternativamente

**PT** Aperte alternadamente

**S** Dra åt växelvis

**FIN** Kierrä vuorotellen

**EST** Pinguldage vaheldumisi

**LAT** Pielieciet pamišus

**LIT** Užsukinėkite pakaitomis

**PL** Śruby dokręcaj naprzemiennie

**RU** Затягивайте попеременно

**CZ** Pokręťta bagażníka dokręcaj dokręcaj naprzemiennie.

**SK** Doťahujte striedavo

**SLO** Privijajte izmenično.

**HR** Naizmjenično zategnite

**HU** Egymástól függetlenül szorítandó

**GR** Σφιγγετε εναλλάξ

**TR** Dönüşümlü sıkın

**中文** 交替拧紧

**한국어** 번갈아 가며 조이십시오.

**日本語** 交互に締め付けてください。

**ไทย** ชั้นโน้แบบสลับ

6

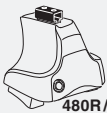

480R/754



480

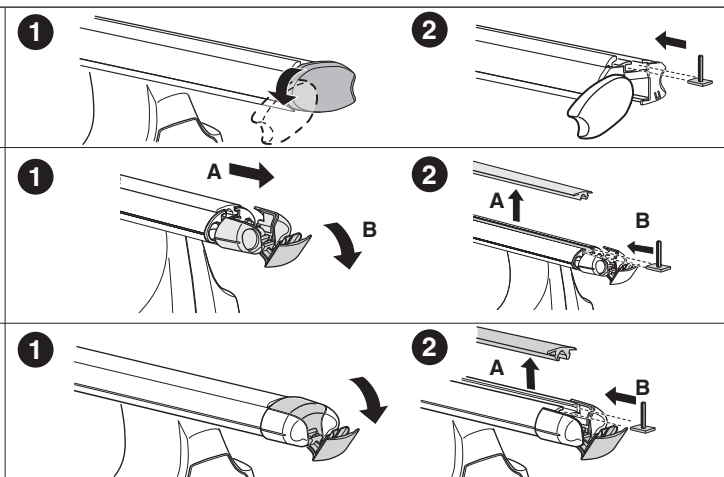
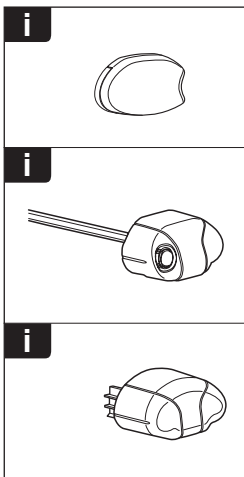
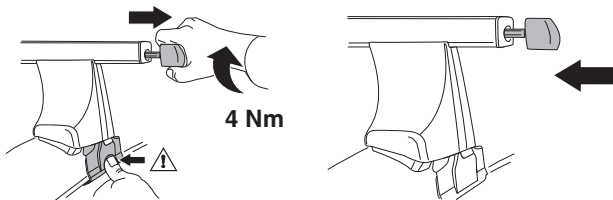
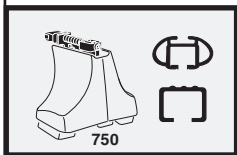
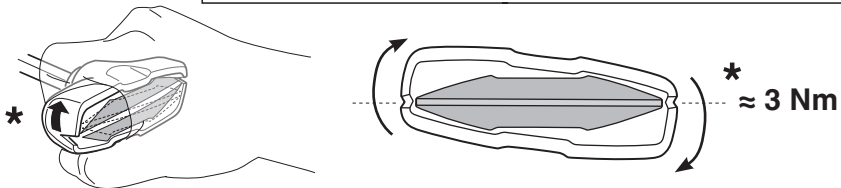
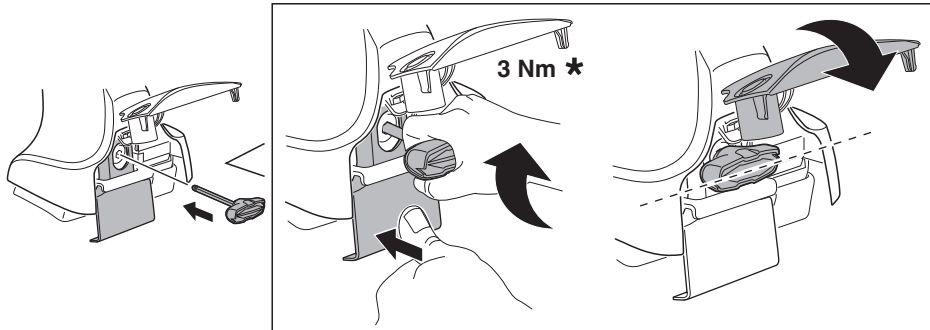

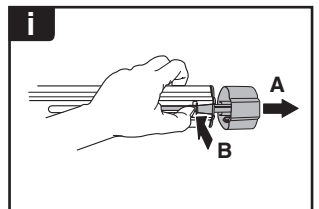
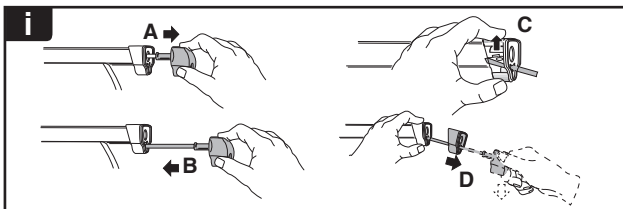
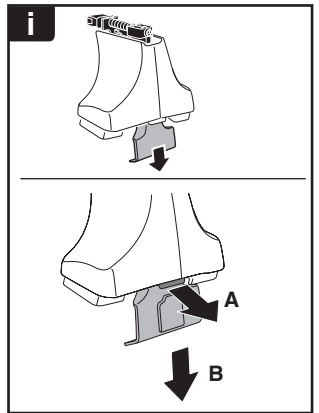
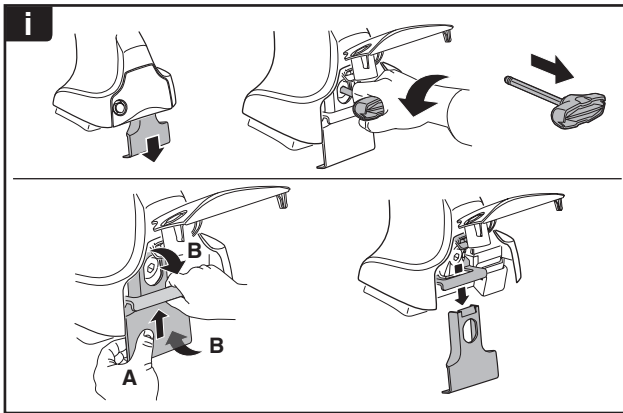
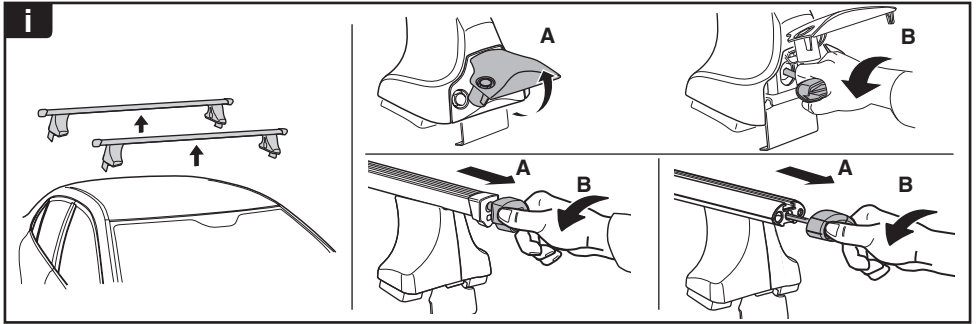

**THULE**  
SWEDEN  
**ONE  
KEY  
SYSTEM**

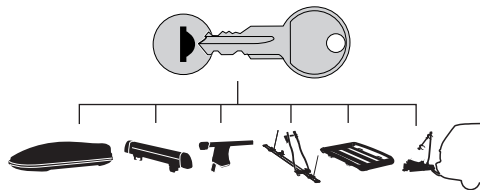

- 544 (x4)
- 596 (x6)
- 588 (x8)
- NA 510 (x10)
- EUR 452 (x12)
- ASIA

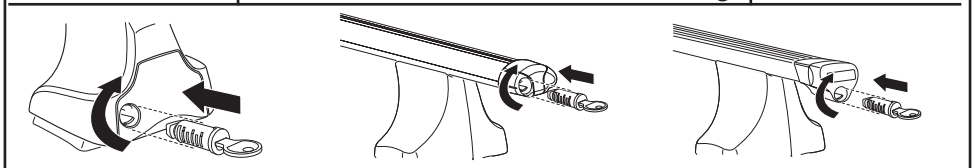

WW ▶ Thule Sweden AB, Box 69, 330 33 Hillerstorp, SWEDEN  
NA ▶ Thule Inc., 42 Silvermine Road, Seymour, Connecticut 06483, USA

info@thule.com  
customer.service@thule.com

www.thule.com