

# Kit 1207

**CHEVROLET Rezzo**, 5-dr Estate, 00-04, 05-  
**DAEWOO Tacuma**, 5-dr Estate, 00-04, 05-  
**DAEWOO Rezzo**, 5-dr Estate, 00-04, 05-

480R  
754

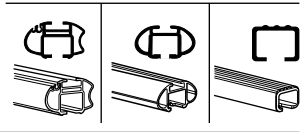
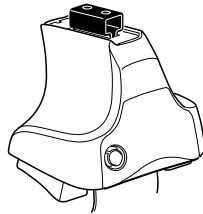

480

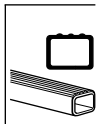
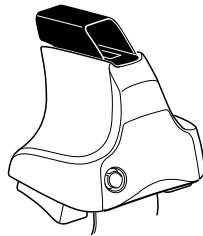

750

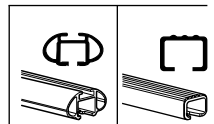
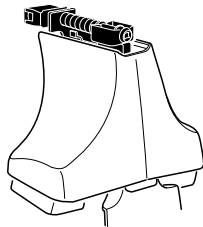

**Kit**



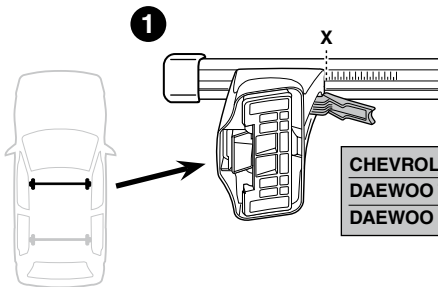
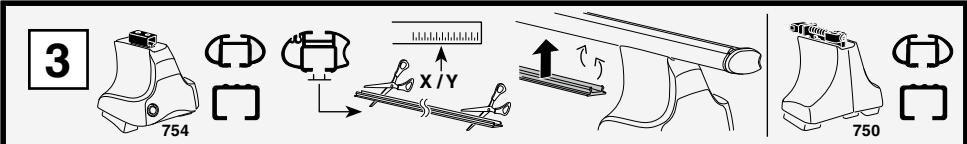

	X
<b>CHEVROLET Rezzo, 5-dr Estate, 00-04, 05-</b>	<b>40,5</b>
<b>DAEWOO Tacuma, 5-dr Estate, 00-04, 05-</b>	<b>40,5</b>
<b>DAEWOO Rezzo, 5-dr Estate, 00-04, 05-</b>	<b>40,5</b>

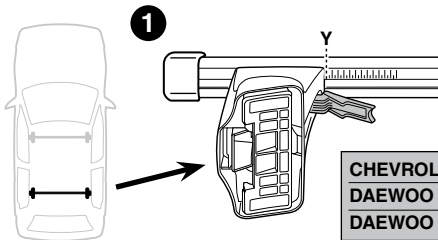
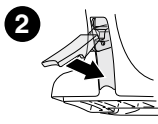

	Y
<b>CHEVROLET Rezzo, 5-dr Estate, 00-04, 05-</b>	<b>36</b>
<b>DAEWOO Tacuma, 5-dr Estate, 00-04, 05-</b>	<b>36</b>
<b>DAEWOO Rezzo, 5-dr Estate, 00-04, 05-</b>	<b>36</b>

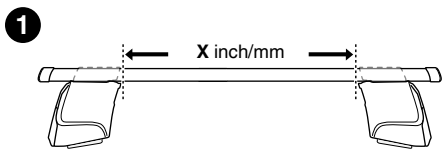
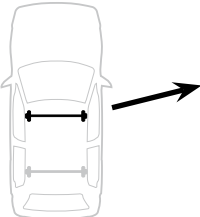
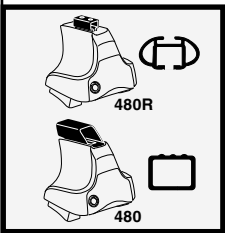
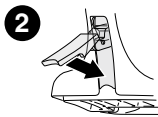

	X inch	X mm
<b>CHEVROLET Rezzo, 5-dr Estate, 00-04, 05-</b>	<b>41 <sup>5</sup>/<sub>8</sub> "</b>	<b>1056 mm</b>
<b>DAEWOO Tacuma, 5-dr Estate, 00-04, 05-</b>	<b>41 <sup>5</sup>/<sub>8</sub> "</b>	<b>1056 mm</b>
<b>DAEWOO Rezzo, 5-dr Estate, 00-04, 05-</b>	<b>41 <sup>5</sup>/<sub>8</sub> "</b>	<b>1056 mm</b>

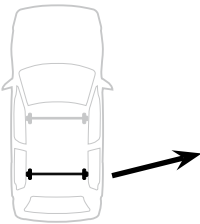
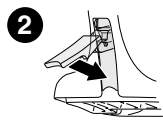

	Y inch	Y mm
<b>CHEVROLET Rezzo, 5-dr Estate, 00-04, 05-</b>	<b>39 <sup>3</sup>/<sub>4</sub> "</b>	<b>1011 mm</b>
<b>DAEWOO Tacuma, 5-dr Estate, 00-04, 05-</b>	<b>39 <sup>3</sup>/<sub>4</sub> "</b>	<b>1011 mm</b>
<b>DAEWOO Rezzo, 5-dr Estate, 00-04, 05-</b>	<b>39 <sup>3</sup>/<sub>4</sub> "</b>	<b>1011 mm</b>

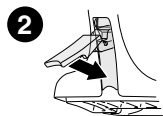

# 4

**CHEVROLET Rezzo**, 5-dr Estate, 00-04, 05-  
**DAEWOO Tacuma**, 5-dr Estate, 00-04, 05-  
**DAEWOO Rezzo**, 5-dr Estate, 00-04, 05-

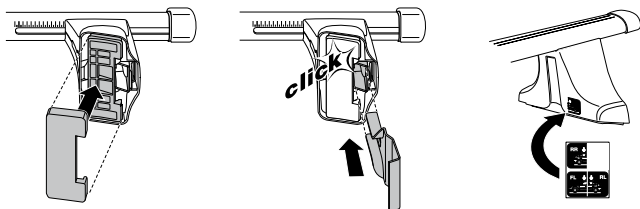
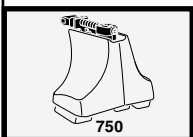
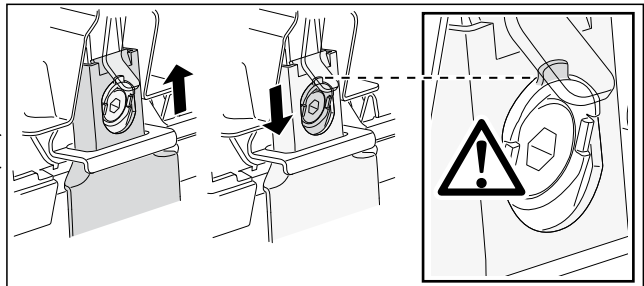
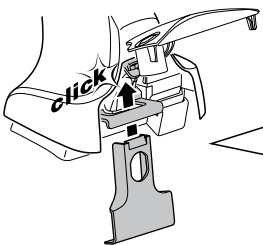
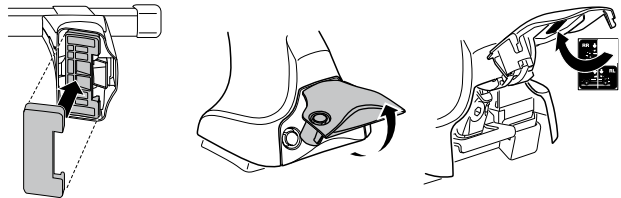
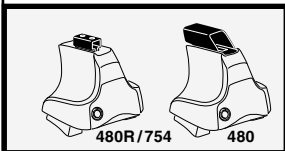
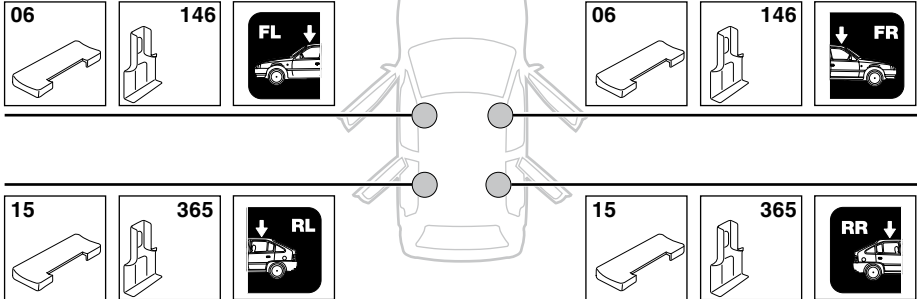

5



	X mm	Y mm	X inch	Y inch
<b>CHEVROLET Rezzo</b> , 5-dr Estate, 00-04, 05-	<b>350 mm</b>	<b>700 mm</b>	<b>13 3/4"</b>	<b>27 1/2"</b>
<b>DAEWOO Tacuma</b> , 5-dr Estate, 00-04, 05-	<b>350 mm</b>	<b>700 mm</b>	<b>13 3/4"</b>	<b>27 1/2"</b>
<b>DAEWOO Rezzo</b> , 5-dr Estate, 00-04, 05-	<b>350 mm</b>	<b>700 mm</b>	<b>13 3/4"</b>	<b>27 1/2"</b>

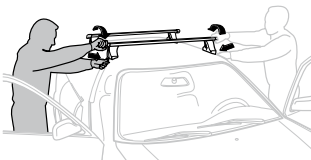
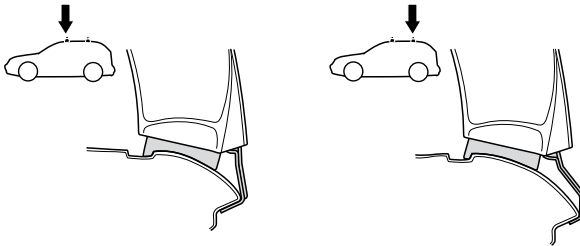
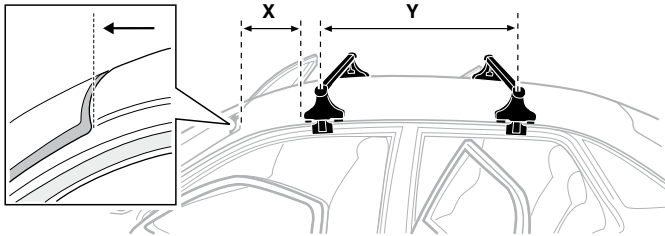

**GB/US** Tighten alternately  
**D** Die Schrauben abwechselnd anziehen  
**F** Serrer alternativement chaque côté  
**NL** Afwisselend aan de linker- en de rechterkant aandraaien  
**I** Alternare il serraggio delle viti  
**E** Apretar alternativamente  
**PT** Aperte alternadamente  
**S** Dra åt växelvis  
**FIN** Kierrä vuorotellen  
**EST** Pinguldage vaheldumisi  
**LAT** Pievelciēt pamīšus  
**LIT** Užsukinėkite pakaitomis  
**PL** Śruby dokręcaj naprzemiennie  
**RU** Затягивайте попеременно

**CZ** Pokręťta багаžníka dokręcaj dokręcaj naprzemiennie.  
**SK** Doťahujte striedavo  
**SLO** Privijajte izmenično.  
**HR** Naizmjenočno zategnite  
**HU** Egy mástól függetlenül szorítandó  
**GR** Σφιγγετε εναλλάξ  
**TR** Dönüşümlü sıkın

**中文** 交替拧紧

**한국어** 번갈아 가며 조이십시오.

**日本語** 交互に締め付けてください。

**ไทย** ชั้้นในแบบสลับ

6



480R/754



480

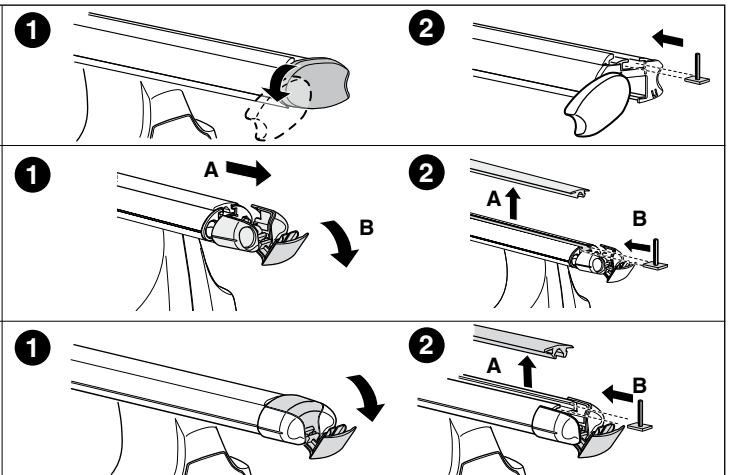
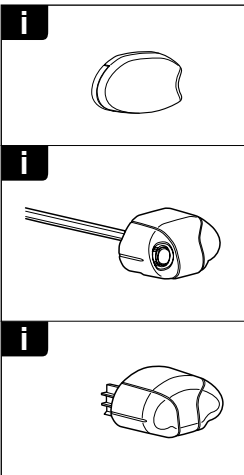
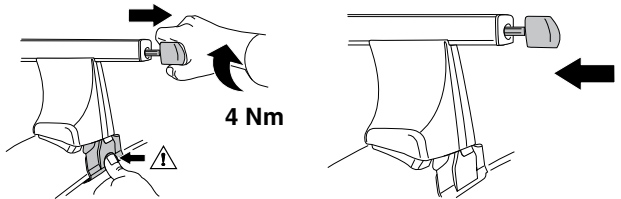
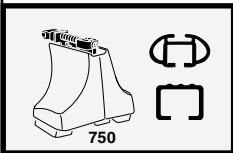
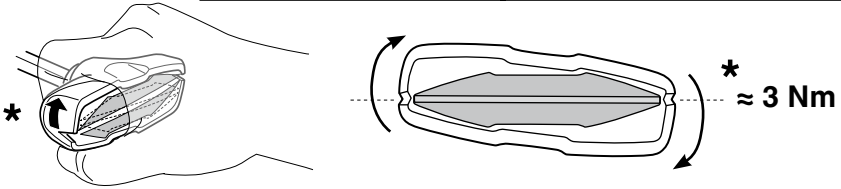
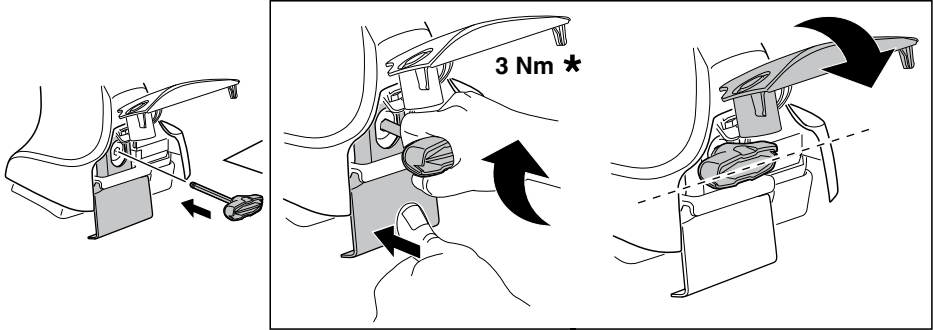

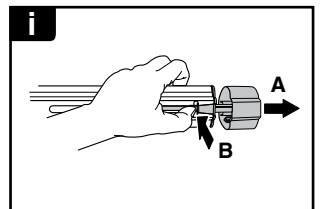
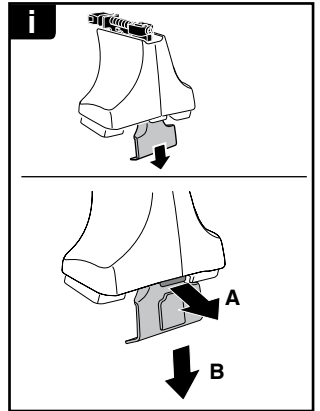

**THULE**  
SWEDEN  
**ONE  
KEY  
SYSTEM**



- 544 (x4)
- 596 (x6)
- 588 (x8)
- NA 510 (x10)
- EUR 452 (x12)
- ASIA



WW ▶ Thule Sweden AB, Box 69, 330 33 Hillerstorp, SWEDEN  
NA ▶ Thule Inc., 42 Silvermine Road, Seymour, Connecticut 06483, USA

info@thule.com  
customer.service@thule.com

www.thule.com