

# Kit 1172

SCION Xb, 5-dr SUV, \*04-07

TOYOTA bB, 5-dr SUV, 00-05

\*North America

480R  
754

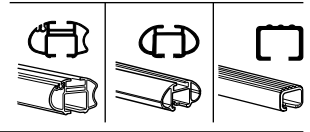
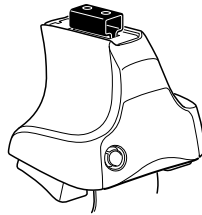

480

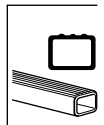
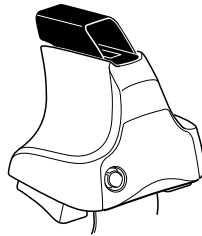

750

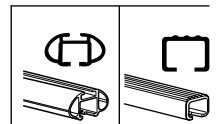
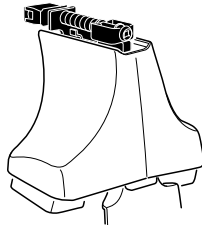





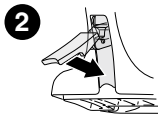
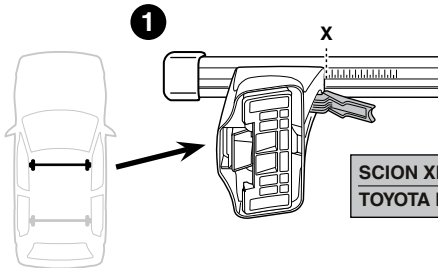
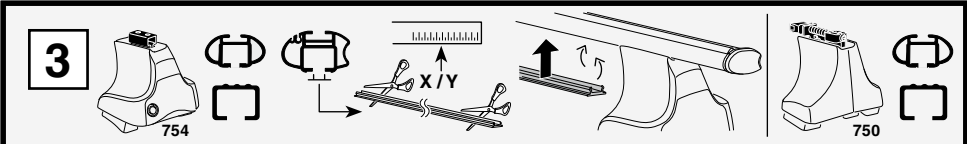

	X
SCION Xb, 5-dr SUV, *04-07	50
TOYOTA bB, 5-dr SUV, 00-05	47,5

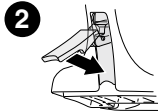
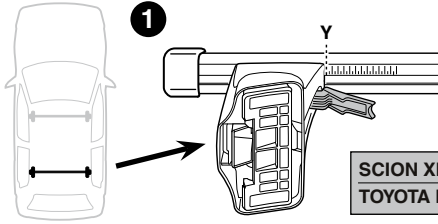

	Y
SCION Xb, 5-dr SUV, *04-07	50
TOYOTA bB, 5-dr SUV, 00-05	47

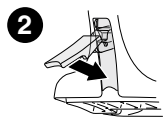
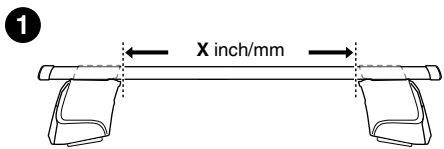
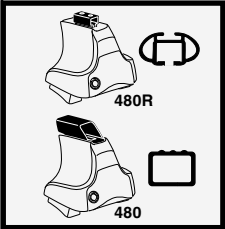

	X inch	X mm
SCION Xb, 5-dr SUV, *04-07	45 1/4"	1151 mm
TOYOTA bB, 5-dr SUV, 00-05	44 3/8"	1126 mm

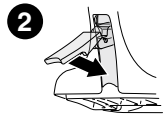
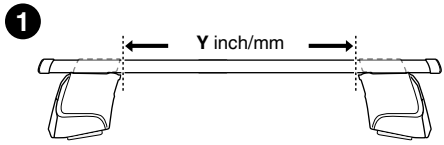
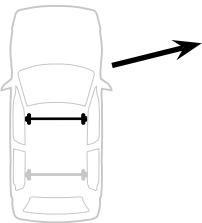

	Y inch	Y mm
SCION Xb, 5-dr SUV, *04-07	45 1/4"	1151 mm
TOYOTA bB, 5-dr SUV, 00-05	44 1/8"	1121 mm

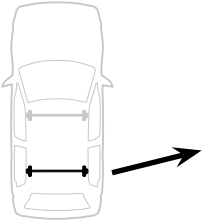

# 4

SCION Xb, 5-dr SUV, \*04-07  
 TOYOTA bB, 5-dr SUV, 00-05

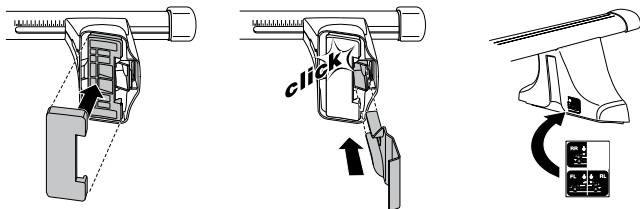
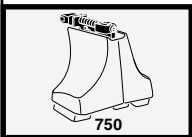
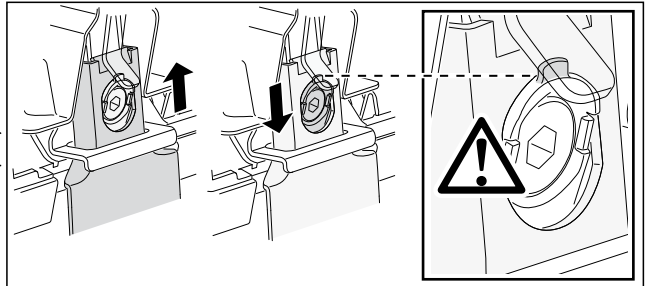
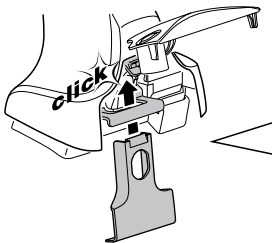
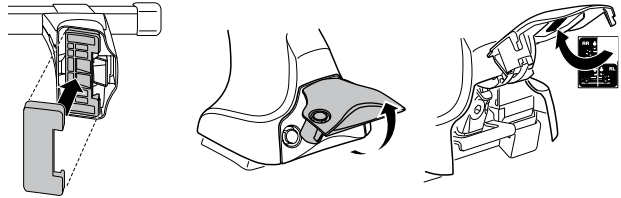
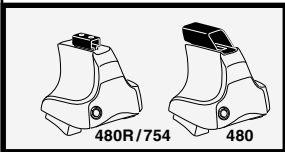
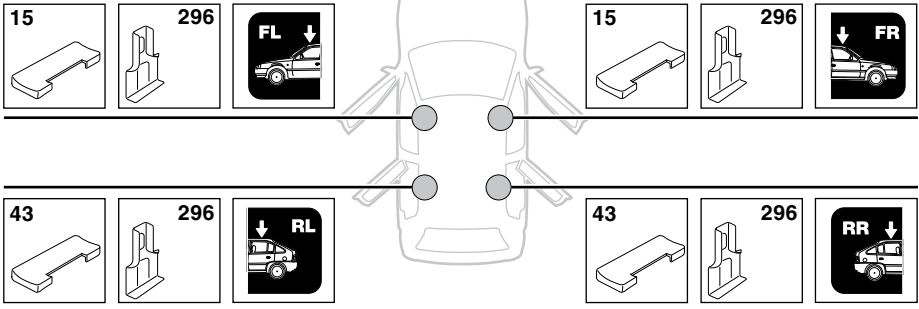

5



	X mm	Y mm	X inch	Y inch
SCION Xb, 5-dr SUV, *04-07	381 mm	711 mm	15 "	28 "
TOYOTA bB, 5-dr SUV, 00-05	400 mm	700 mm	15 3/4 "	27 1/2 "

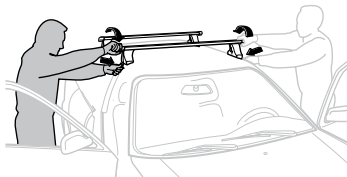
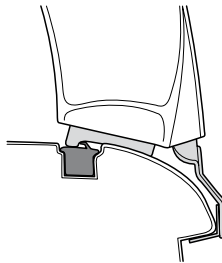
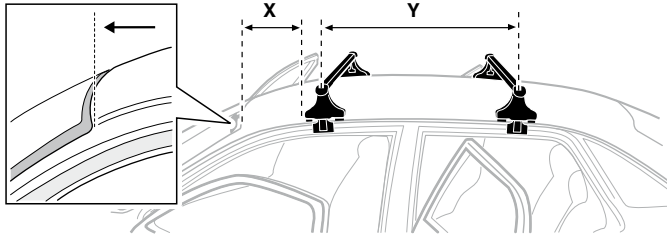

**GB/US** Tighten alternately

**D** Die Schrauben abwechselnd anziehen

**F** Serrer alternativement chaque côté

**NL** Afwisselend aan de linker- en de rechterkant aandraaien

**I** Alternare il serraggio delle viti

**E** Apertar alternativamente

**PT** Aperte alternadamente

**S** Dra åt växelvis

**FIN** Kierrä vuorotellen

**EST** Pinguldage vaheldumisi

**LAT** Pieveļciēt pamišus

**LIT** Užsukinėkite pakaitomis

**PL** Śruby dokręcaj naprzemiennie

**RU** Затягивайте попеременно

**CZ** Pokręťta багаžníka dokręcaj dokręcaj naprzemiennie.

**SK** Doťahujte striedavo

**SLO** Privijajte izmenično.

**HR** Naizmjenično zategnite

**HU** Egymástól függetlenül szorítandó

**GR** Σφιγγετε εναλλάξ

**TR** Dönüşümlü sıkın

**中文** 交替拧紧

**한국어** 번갈아 가며 조이십시오.

**日本語** 交互に締め付けてください。

**ไทย** ชันโนแบบสลับ

6



480R/754



480

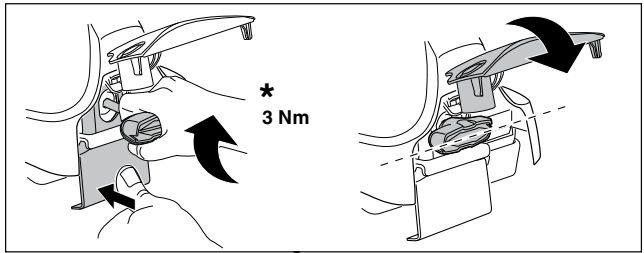
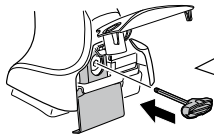

\*  
3 Nm

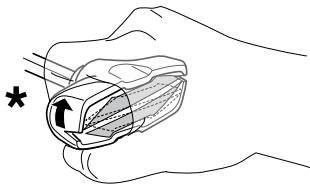

\*



\*  
≈ 3 Nm

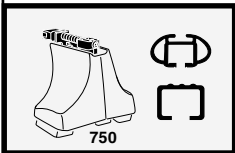
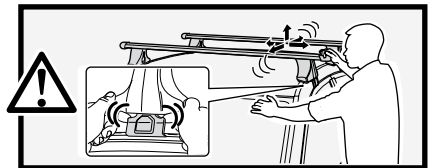

750

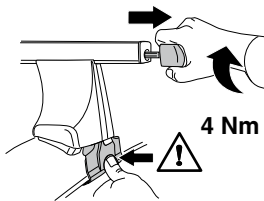

4 Nm

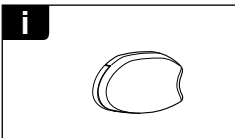
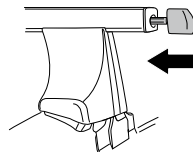

i

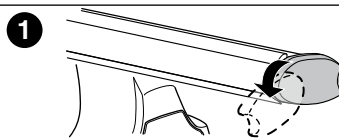

1

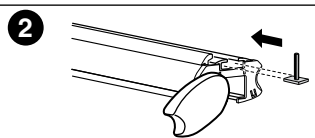

2

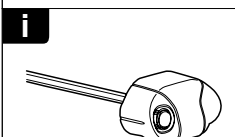

i

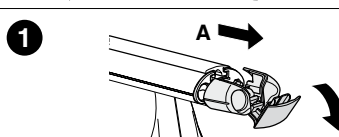

1

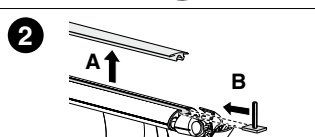

2

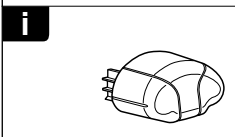

i

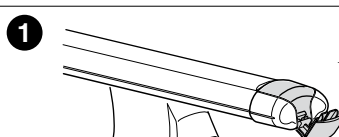

1

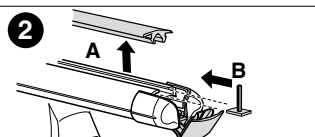

2



**THULE**  
SWEDEN  
**ONE  
KEY  
SYSTEM**



- 544 (x4)
- 596 (x6)
- 588 (x8)
- NA 510 (x10)
- EUR 452 (x12)
- ASIA



ww ▶ Thule Sweden AB, Box 69, 330 33 Hillerstorp, SWEDEN  
NA ▶ Thule Inc., 42 Silvermine Road, Seymour, Connecticut 06483, USA

info@thule.com  
customer.service@thule.com

www.thule.com