

Kit 1149

HOLDEN Commodore V.T, 4-dr Sedan, 97-05

480R
754

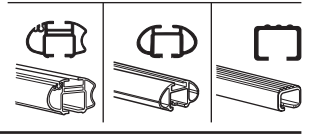
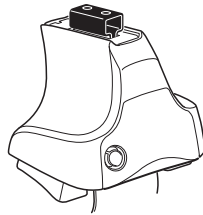

480

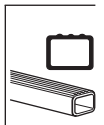
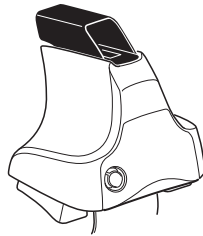

750

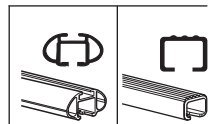
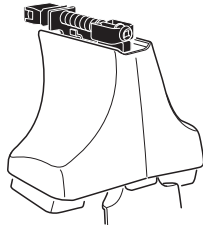

Kit

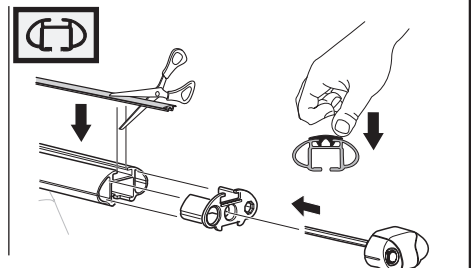
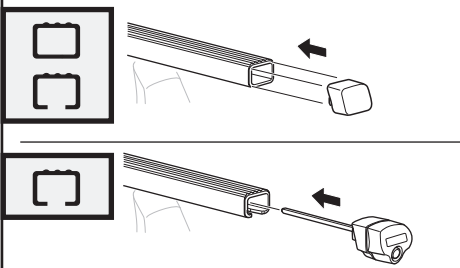
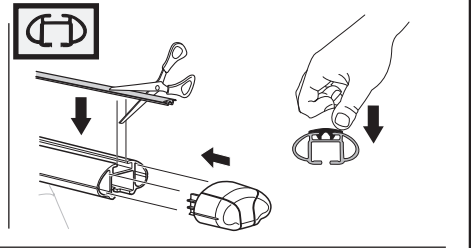
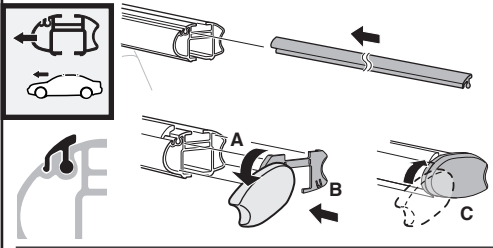
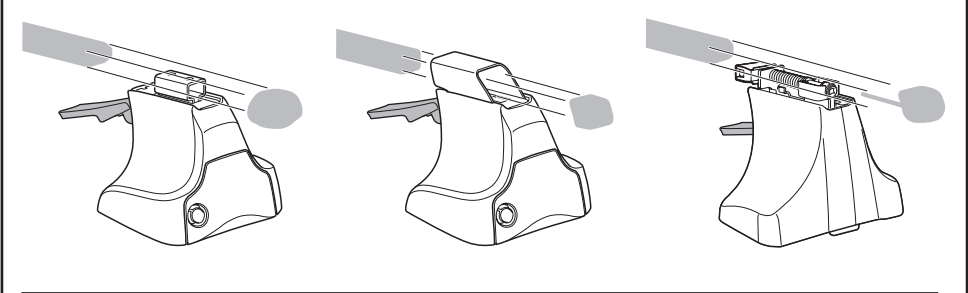
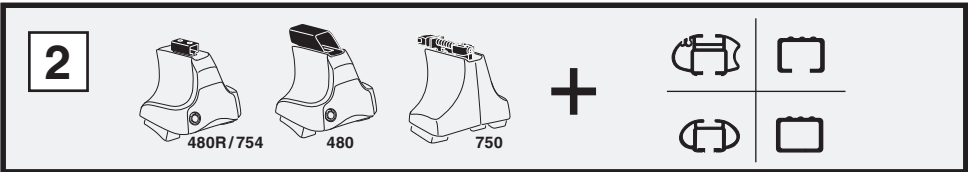
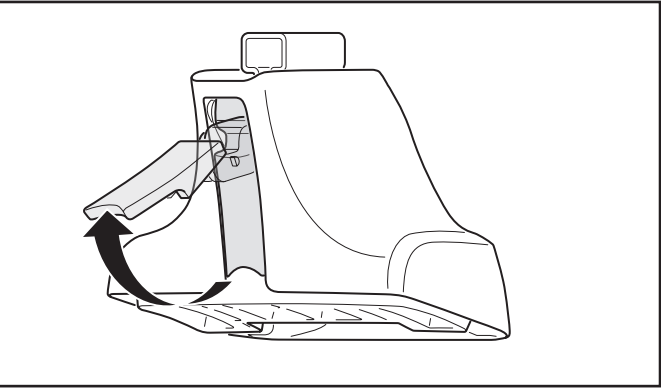
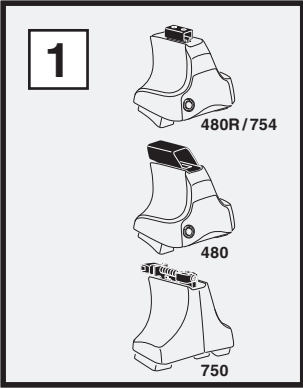

3

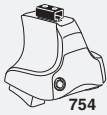

754

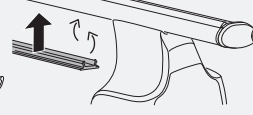
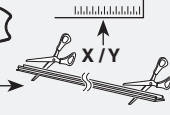

750

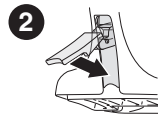
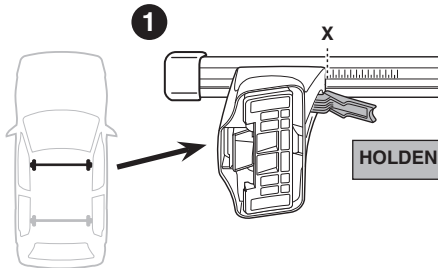

| | |
|--|-----------|
| HOLDEN Commodore V.T, 4-dr Sedan, 97-05 | X |
| | 41 |

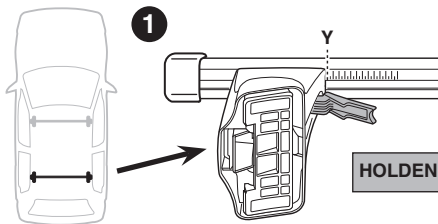

| | |
|--|-------------|
| HOLDEN Commodore V.T, 4-dr Sedan, 97-05 | Y |
| | 41,5 |



480R



480

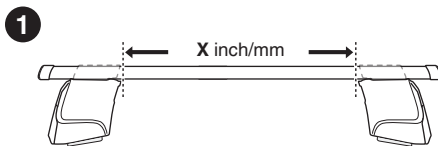

| | | |
|--|----------------|----------------|
| HOLDEN Commodore V.T, 4-dr Sedan, 97-05 | X inch | X mm |
| | 41 3/4" | 1061 mm |

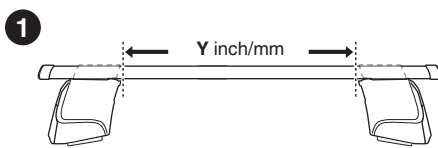

| | | |
|--|---------------|----------------|
| HOLDEN Commodore V.T, 4-dr Sedan, 97-05 | Y inch | Y mm |
| | 42" | 1066 mm |

4

HOLDEN Commodore V.T, 4-dr Sedan, 97-05

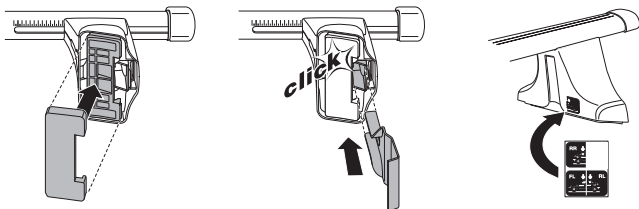
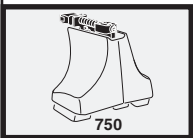
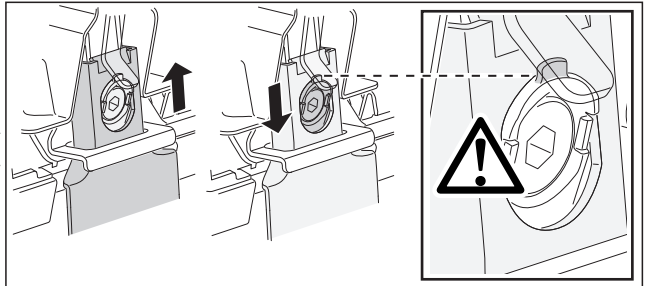
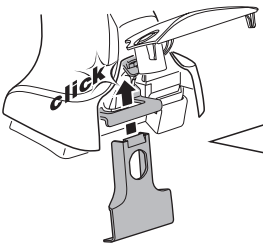
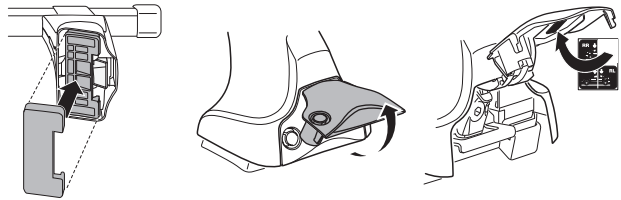
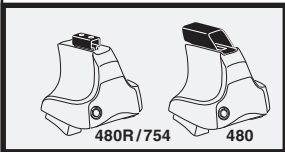
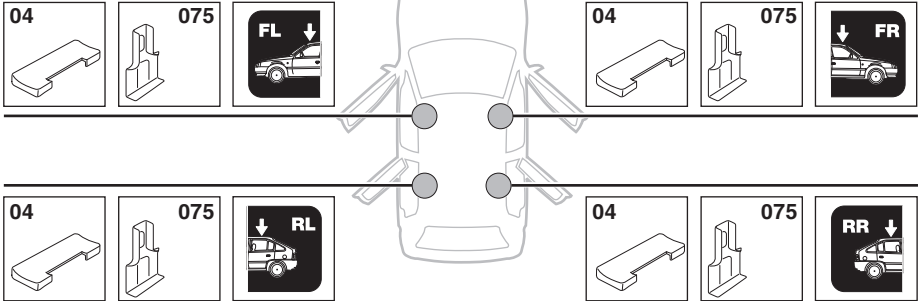

5

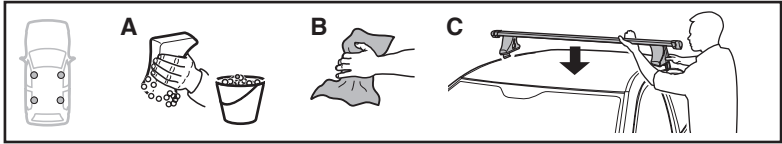

| | X mm | Y mm | X inch | Y inch |
|--|---------------|---------------|----------------|------------|
| HOLDEN Commodore V.T, 4-dr Sedan, 97-05 | 270 mm | 710 mm | 10 5/8" | 28" |

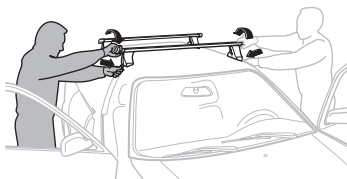
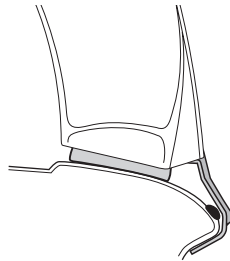
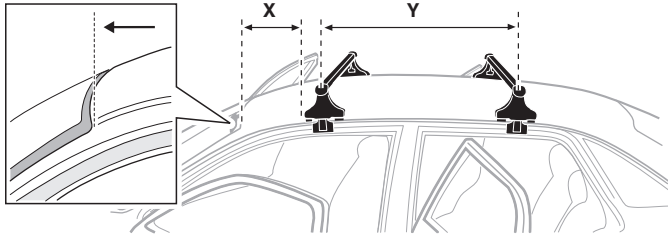

GB/US Tighten alternately

D Die Schrauben abwechselnd anziehen

F Serrer alternativement chaque côté

NL Afwisselend aan de linker- en de rechterkant aandraaien

I Alternare il serraggio delle viti

E Apretar alternativamente

PT Aperte alternadamente

S Dra åt växelvis

FIN Kierrä vuorotellen

EST Pinguldage vaheldumisi

LAT Pieveļciet pamišus

LIT Užsukinėkite pakaitomis

PL Śruby dokręcaj naprzemiennie

RU Затягивайте попеременно

CZ Pokręťta bagażníka dokręcaj dokręcaj naprzemiennie.

SK Doťahujte striedavo

SLO Privijajte izmenično.

HR Naizmjenično zategnite

HU Egymástól függetlenül szorítandó

GR Σφιγγετε εναλλάξ

TR Dönüşümlü sıkın

中文 交替拧紧

한국어 번갈아 가며 조이십시오.

日本語 交互に締め付けてください。

ไทย ชันโนแบบสลับ

6



480R/754



480

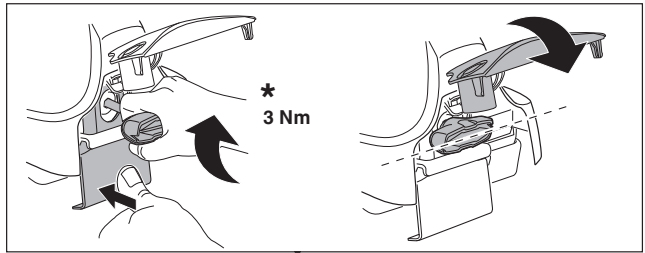
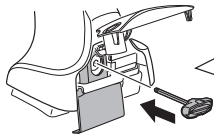

*
3 Nm

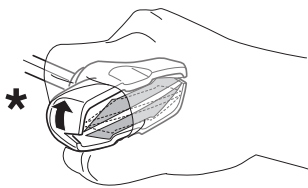

*

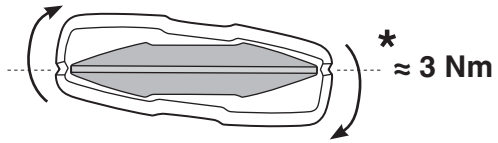

*
≈ 3 Nm

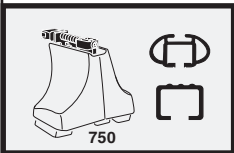
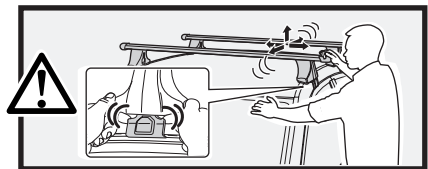

750

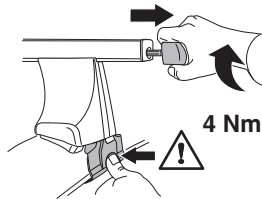

4 Nm

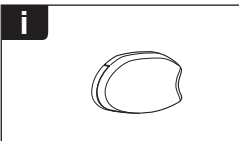
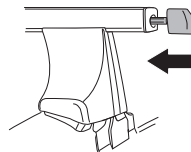

i

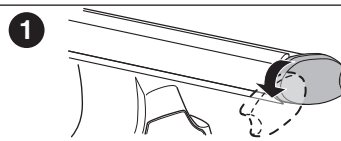

1

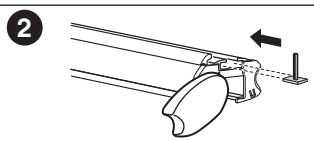

2

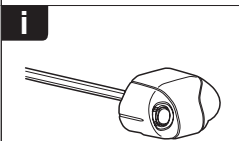

i

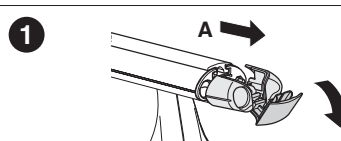

1

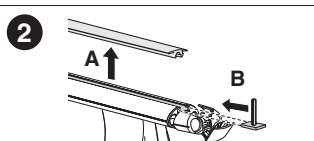

2

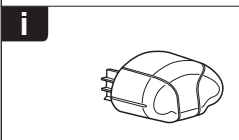

i

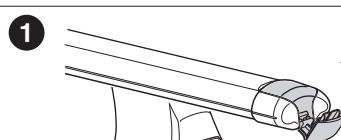

1

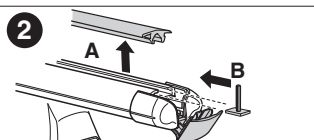

2

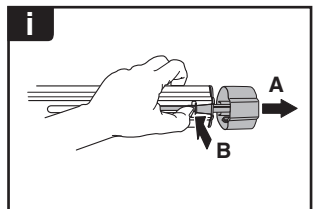
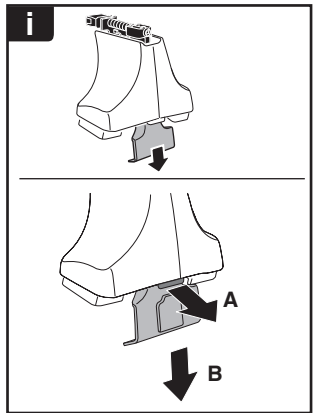
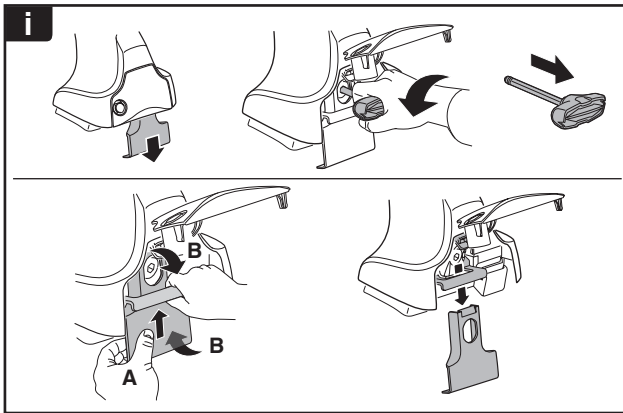
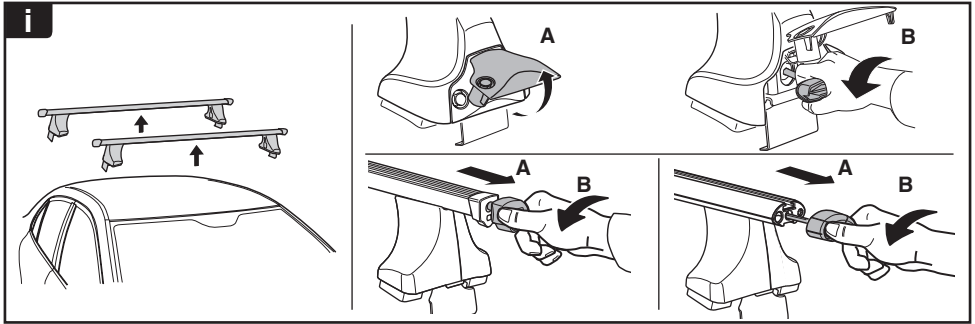

THULE
SWEDEN
**ONE
KEY
SYSTEM**

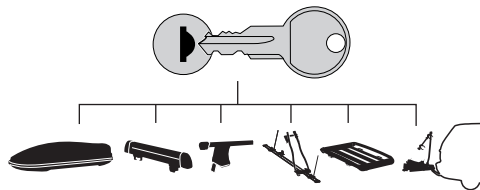

- 544 (x4)
- 596 (x6)
- 588 (x8)
- NA 510 (x10)
- EUR 452 (x12)
- ASIA

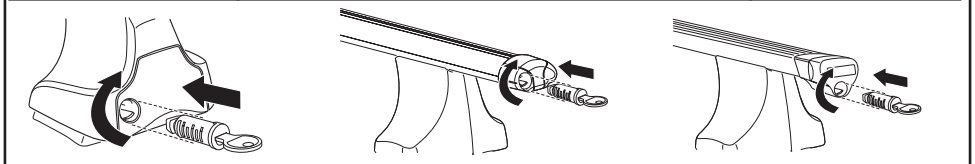

WW ▶ Thule Sweden AB, Box 69, 330 33 Hillerstorp, SWEDEN
NA ▶ Thule Inc., 42 Silvermine Road, Seymour, Connecticut 06483, USA

info@thule.com
customer.service@thule.com

www.thule.com