

Kit 1056

CITROËN Xsara, 3-dr Hatchback, 98-00, 01-06

CITROËN Xsara, 5-dr Hatchback, 98-00, 01-06

480R
754

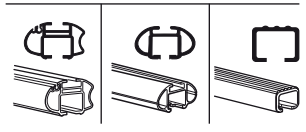
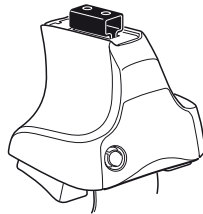

480

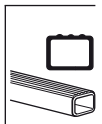
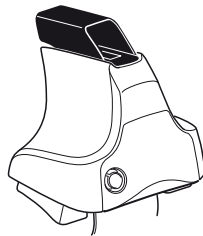

750

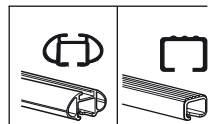
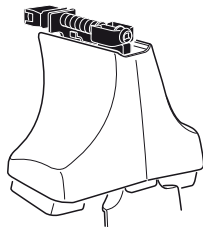

CITROËN Xsara, 3-dr Hatchback, 98-00, 01-06

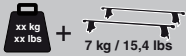

= Max.
55kg/121 lbs

CITROËN Xsara, 5-dr Hatchback, 98-00, 01-06

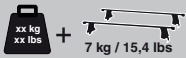

= Max.
60kg/132 lbs

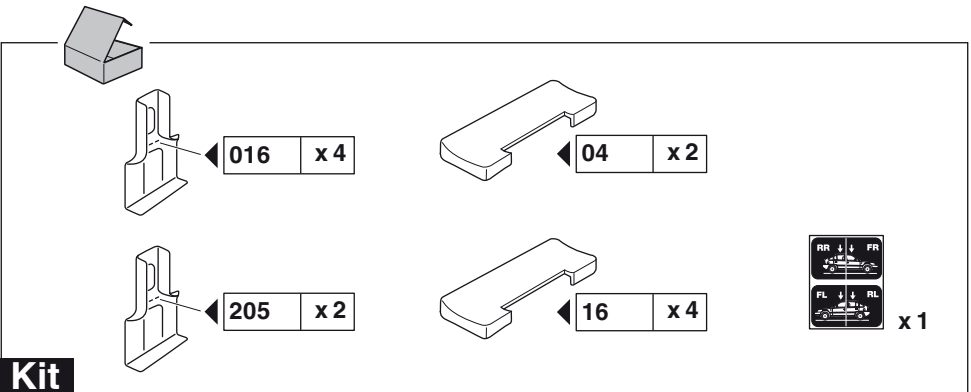
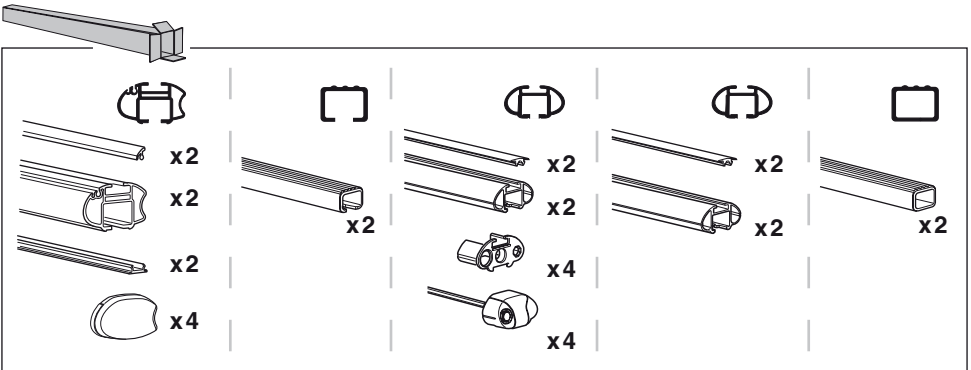
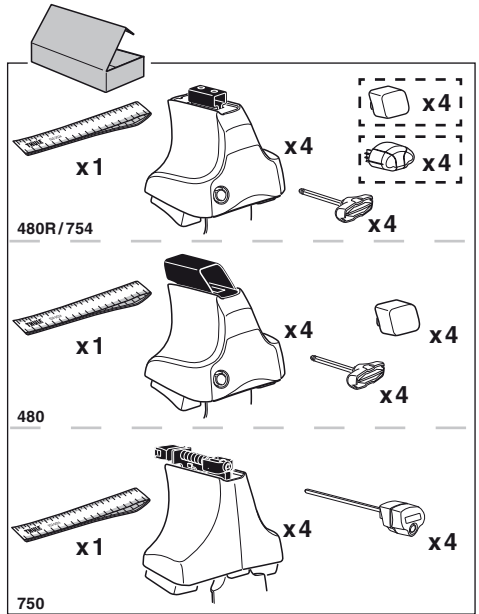
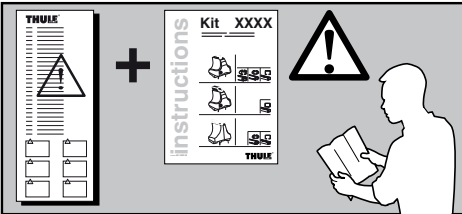
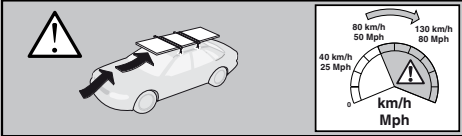

Kit

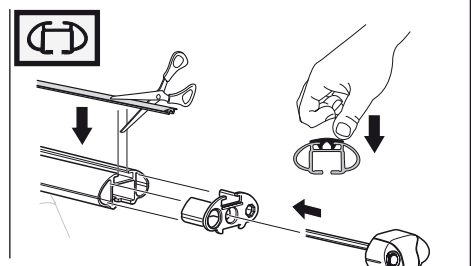
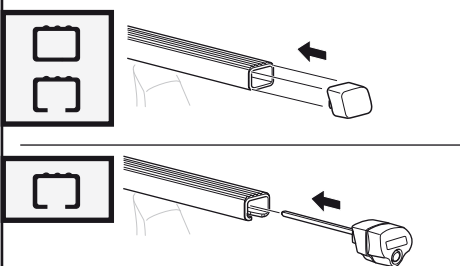
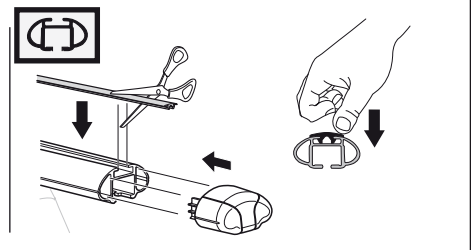
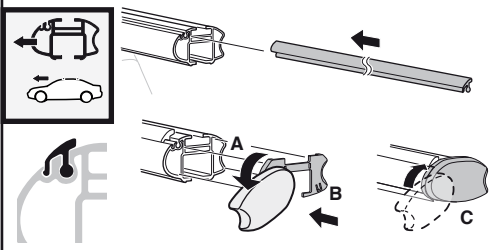
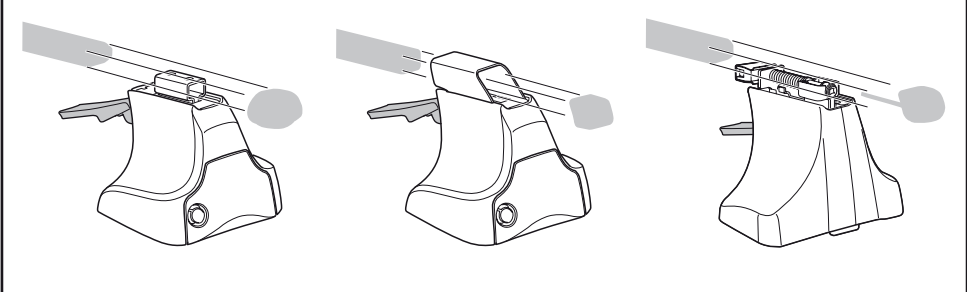
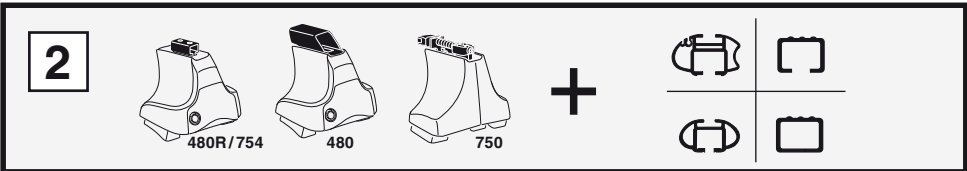
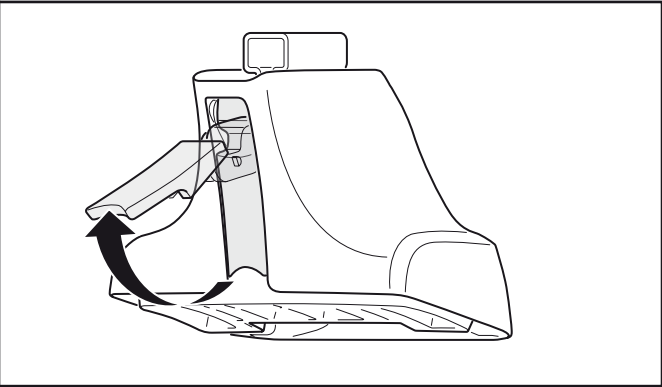
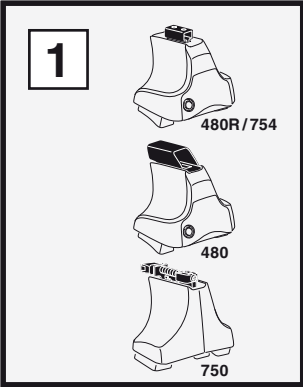



1

2

| | X |
|--|----|
| CITROËN Xsara, 3-dr Hatchback, 98-00, 01-06 | 21 |
| CITROËN Xsara, 5-dr Hatchback, 98-00, 01-06 | 21 |

1

2

| | Y |
|--|------|
| CITROËN Xsara, 3-dr Hatchback, 98-00, 01-06 | 21 |
| CITROËN Xsara, 5-dr Hatchback, 98-00, 01-06 | 18,5 |

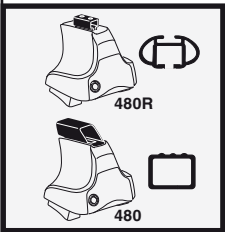

1

2

| | X inch | X mm |
|--|----------------------------------|--------|
| CITROËN Xsara, 3-dr Hatchback, 98-00, 01-06 | 33 ⁷ / ₈ " | 861 mm |
| CITROËN Xsara, 5-dr Hatchback, 98-00, 01-06 | 33 ⁷ / ₈ " | 861 mm |

1

2

| | Y inch | Y mm |
|--|----------------------------------|--------|
| CITROËN Xsara, 3-dr Hatchback, 98-00, 01-06 | 33 ⁷ / ₈ " | 861 mm |
| CITROËN Xsara, 5-dr Hatchback, 98-00, 01-06 | 32 ⁷ / ₈ " | 836 mm |

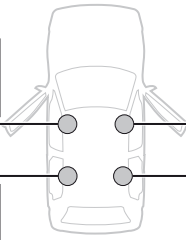
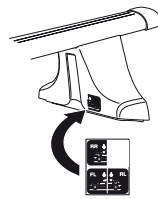
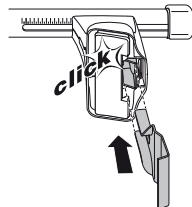
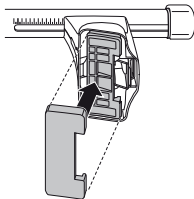
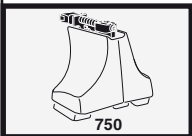
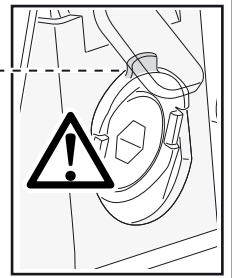
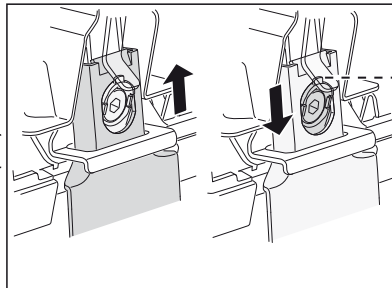
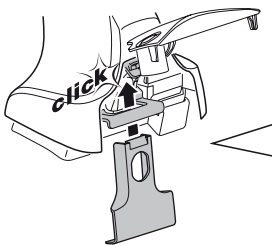
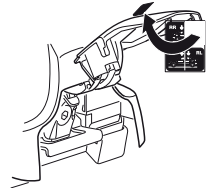
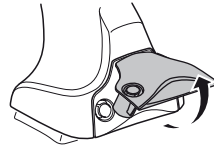
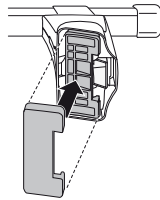
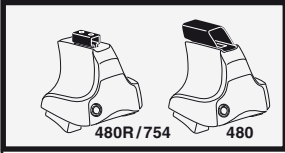
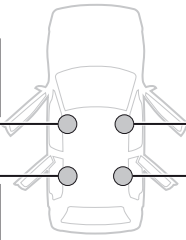
4**CITROËN Xsara, 3-dr Hatchback, 98-00, 01-06****CITROËN Xsara, 5-dr Hatchback, 98-00, 01-06**

5



| | X mm | Y mm | X inch | Y inch |
|--|--------|--------|--------|--------|
| CITROËN Xsara, 3-dr Hatchback, 98-00, 01-06 | 140 mm | 660 mm | 5 1/2" | 26" |
| CITROËN Xsara, 5-dr Hatchback, 98-00, 01-06 | 140 mm | 660 mm | 5 1/2" | 26" |

CITROËN Xsara, 3-dr Hatchback, 98-00, 01-06

CITROËN Xsara, 5-dr Hatchback, 98-00, 01-06

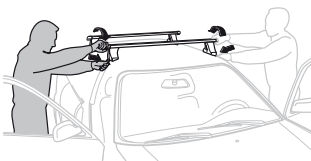
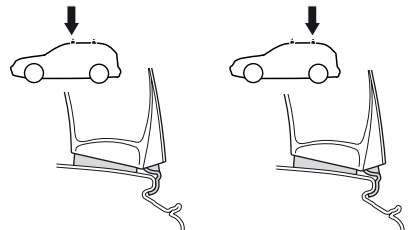
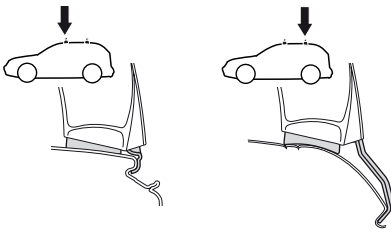
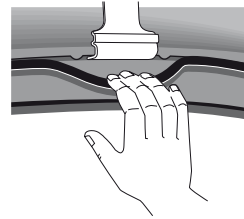
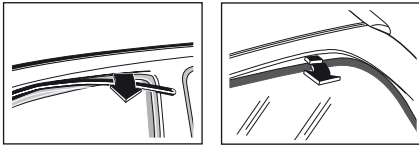
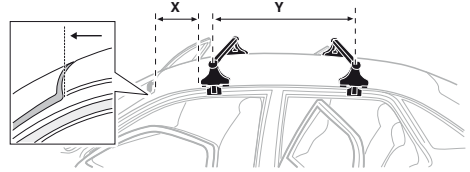
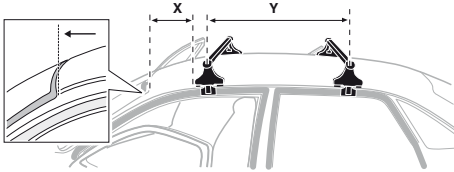

- GB/US** Tighten alternately
- D** Die Schrauben abwechselnd anziehen
- F** Serrer alternativement chaque côté
- NL** Afwisselend aan de linker- en de rechterkant aandraaien
- I** Alternare il serraggio delle viti
- E** Apretar alternativamente
- PT** Aperte alternadamente
- S** Dra åt växelvis
- FIN** Kierrä vuorotellen
- EST** Pinguldage vaheldumisi
- LAT** Pieļvelciēt pamiēšus
- LIT** Užsukinėkite pakaitomis
- PL** Śruby dokręcaj naprzemiennie
- RU** Затягивайте попеременно

- CZ** Pokręťta багаžníka dokręcaj naprzemiennie.
- SK** Dofahujte striedavo
- SLO** Privijajte izmenično.
- HR** Naizmjenično zategnite
- HU** Egymástól függetlenül szorítandó
- GR** Σφιγγετε εναλλάξ
- TR** Dönüşümlü sıkın

中文 交替拧紧

한국어 번갈아 가며 조이십시오.

日本語 交互に締め付けてください。

ไทย ชั้้นในแบบสลับ

6



480R/754



480

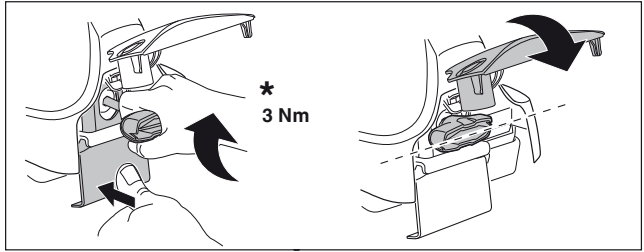
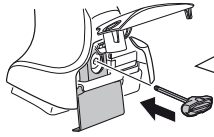

*
3 Nm

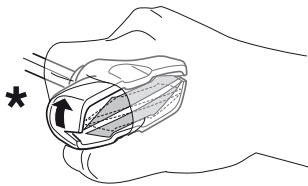

*

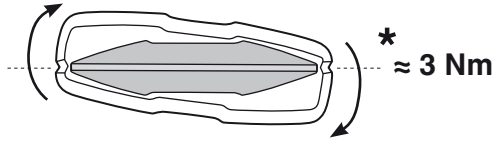

*
≈ 3 Nm

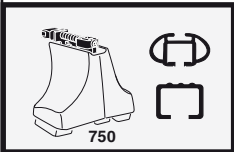
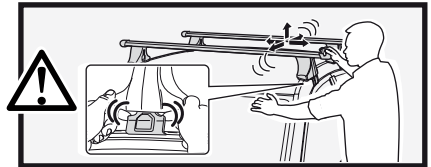

750

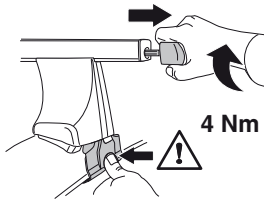

4 Nm

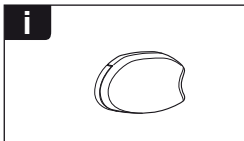
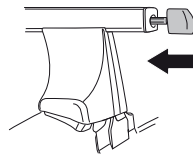

i

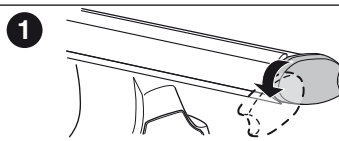

1

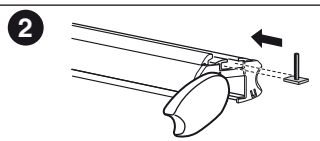

2

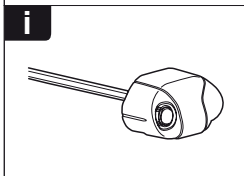

i

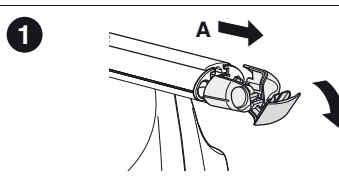

1

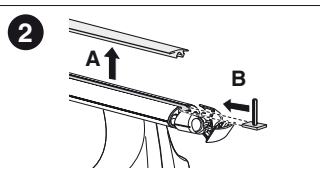

2

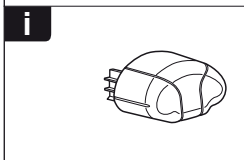

i

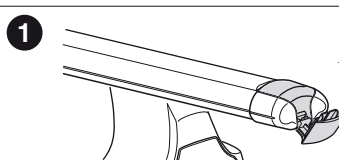

1

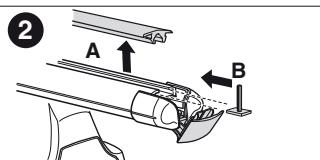

2

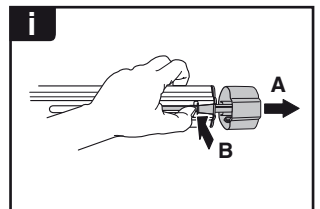
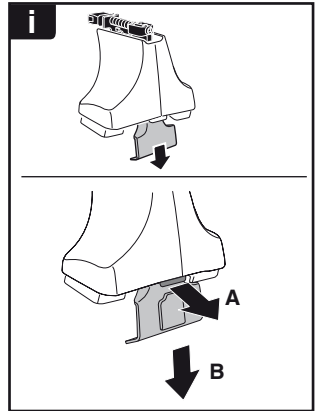
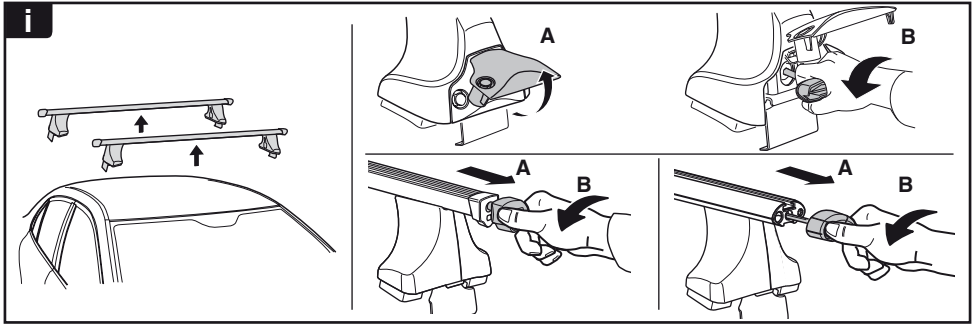

THULE
SWEDEN
**ONE
KEY
SYSTEM**



- 544 (x4)
- 596 (x6)
- 588 (x8)
- NA 510 (x10)
- EUR 452 (x12)
- ASIA



WW ▶ Thule Sweden AB, Box 69, 330 33 Hillerstorp, SWEDEN
 NA ▶ Thule Inc., 42 Silvermine Road, Seymour, Connecticut 06483, USA

info@thule.com
 customer.service@thule.com

www.thule.com