

# Kit 1601

HYUNDAI ix 35, 5-dr SUV, 10-

This Kit is only for vehicles without railing.

480R  
754

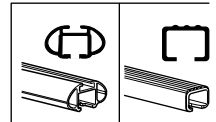
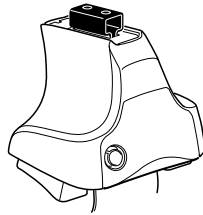

480

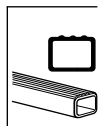
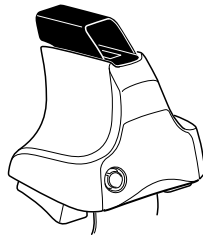

**Kit**

1

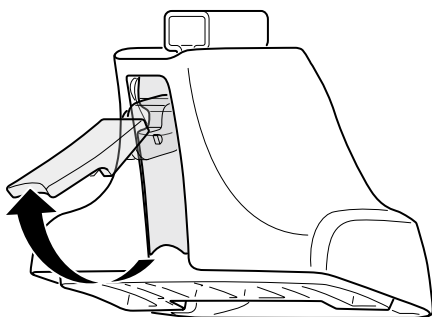
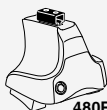

2



+

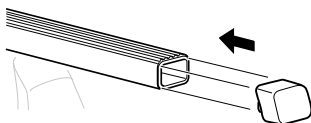
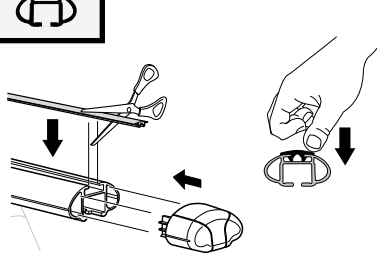
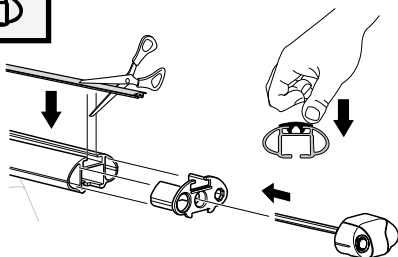
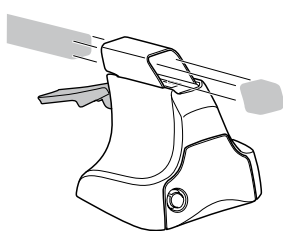
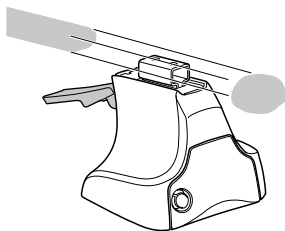

**3**

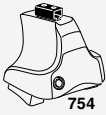

**1**

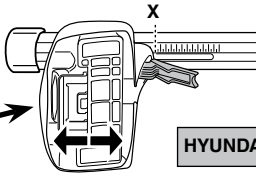
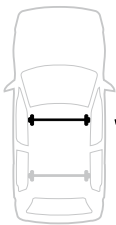

**2**

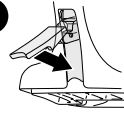

HYUNDAI ix 35, 5-dr SUV, 10-

X
42,5

**1**

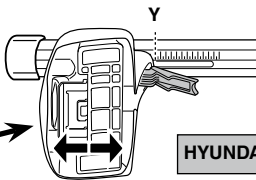

**2**

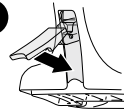

HYUNDAI ix 35, 5-dr SUV, 10-

Y
39



**1**

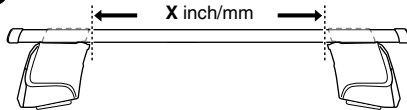
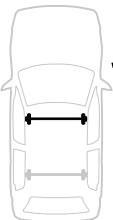

**2**

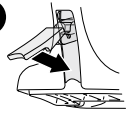

HYUNDAI ix 35, 5-dr SUV, 10-

X inch	X mm
42 3/8"	1076 mm

**1**

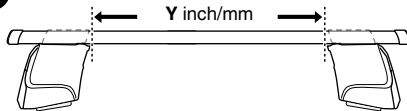

**2**

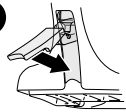

HYUNDAI ix 35, 5-dr SUV, 10-

Y inch	Y mm
41"	1041 mm

4



480R/754



480

HYUNDAI ix 35, 5-dr SUV, 10-

204



270



206



270



137



820



137



820

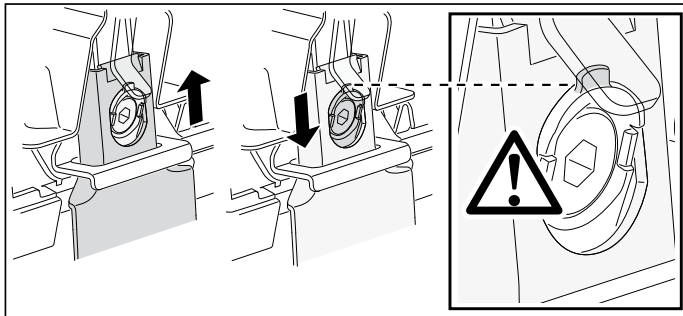
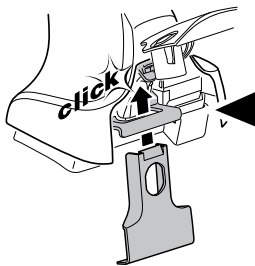
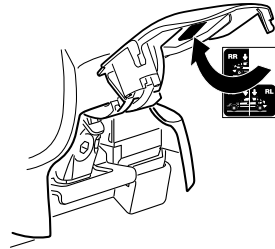
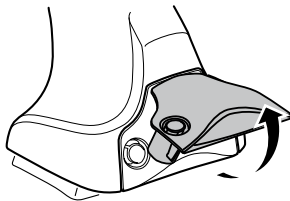
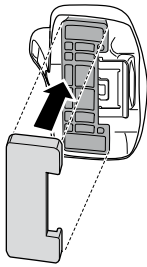

5

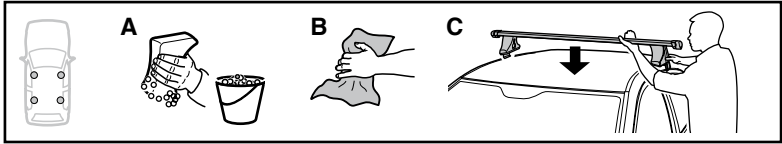

	X mm	Y mm	X inch	Y inch
HYUNDAI ix 35, 5-dr SUV, 10-	300 mm	620 mm	11 3/4"	24 3/8"

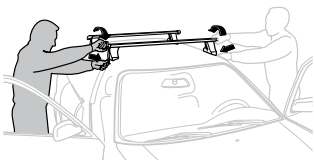
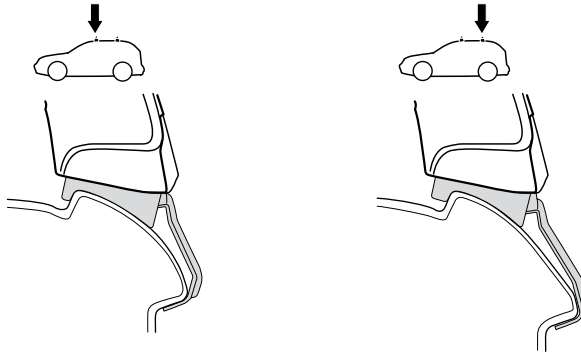
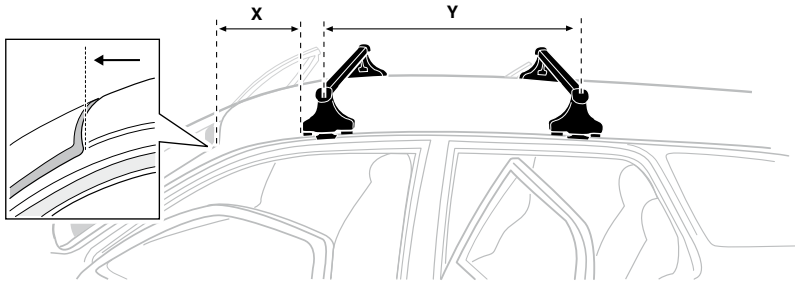

**GB/US** Tighten alternately

**D** Die Schrauben abwechselnd anziehen

**F** Serrer alternativement chaque côté

**NL** Afwisselend aan de linker- en de rechterkant aandraaien

**I** Alternare il serraggio delle viti

**E** Apretar alternativamente

**PT** Aperte alternadamente

**S** Dra åt växelvis

**FIN** Kierrä vuorotellen

**EST** Pinguldage vaheldumisi

**LAT** Pieļieciet pamāšus

**LIT** Užsukinėkite pakaitomis

**PL** Śruby dokręcaj naprzemiennie

**RU** Затягивайте попеременно

**CZ** Pokręťta bagażníka dokręcaj dokręcaj naprzemiennie.

**SK** Dotahujte striedavo

**SLO** Privijajte izmenično.

**HR** Naizmjениčno zategните

**HU** Egymástól függetlenül szorítandó

**GR** Σφιγγετε εναλλάξ

**TR** Dönüşümlü sıkın

**中文** 交替拧紧

**한국어** 번갈아 가며 조이십시오.

**日本語** 交互に締め付けてください。

**ไทย** ชนไนแบบสลับ

**ไทย** ชนไนแบบสลับ

**ไทย** ชนไนแบบสลับ

**ไทย** ชนไนแบบสลับ

**ไทย** ชนไนแบบสลับ

**ไทย** ชนไนแบบสลับ

**ไทย** ชนไนแบบสลับ

**ไทย** ชนไนแบบสลับ

**ไทย** ชนไนแบบสลับ

**ไทย** ชนไนแบบสลับ

**ไทย** ชนไนแบบสลับ

6

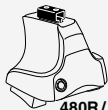

480R/754



480

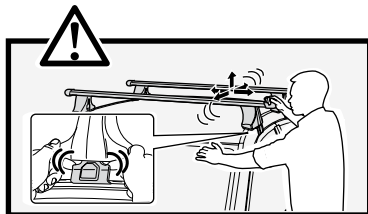
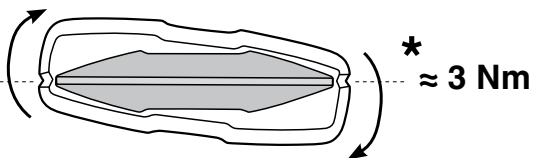
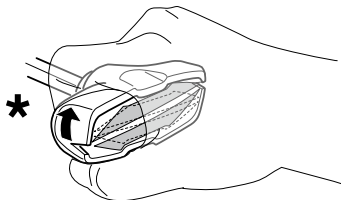
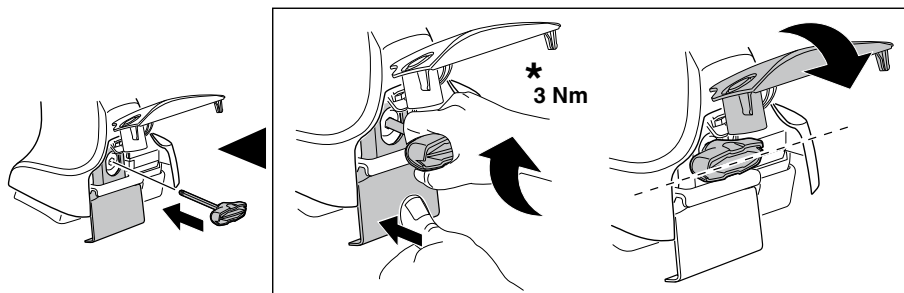

7

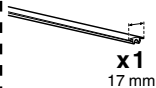



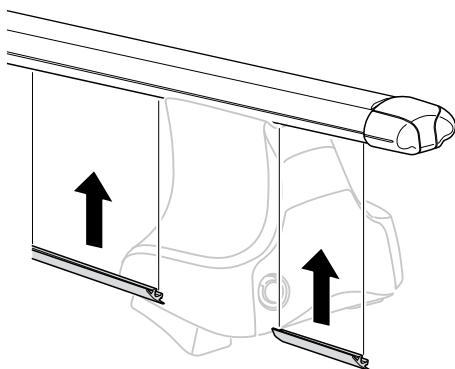

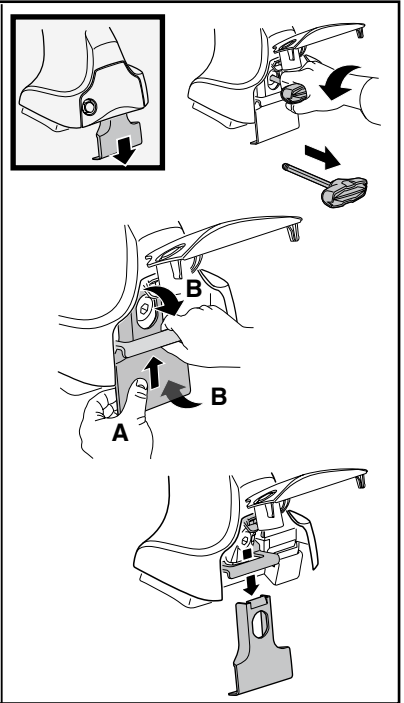
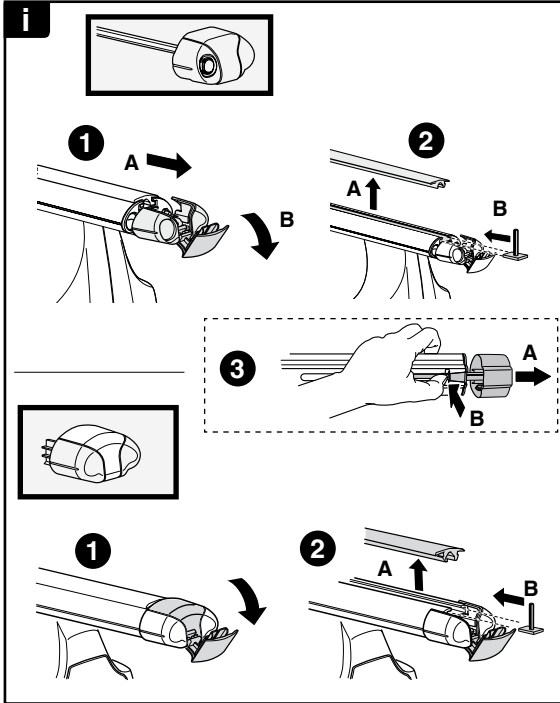
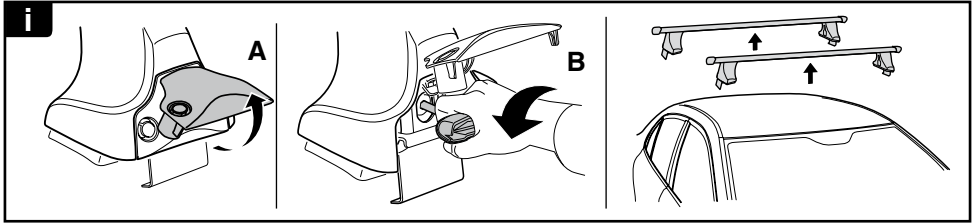
x1  
17 mm



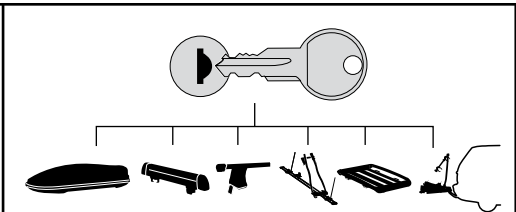

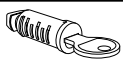
**THULE**  
SWEDEN  
**ONE  
KEY  
SYSTEM**



-  **544** (x4)
  -  **596** (x6)
  -  **588** (x8)
  -  **510** (x10)
  -  **452** (x12)
- NA  
EUR  
ASIA

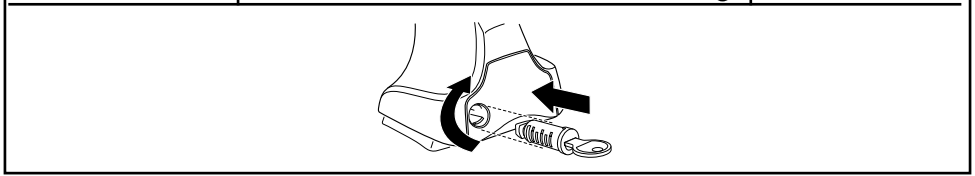

WW ▶ Thule Sweden AB, Box 69, 330 33 Hillerstorp, SWEDEN  
NA ▶ Thule Inc., 42 Silvermine Road, Seymour, Connecticut 06483, USA

info@thule.com  
customer.service@thule.com

 www.thule.com