

# Kit 1204

MERCEDES C-Klasse, 4-dr Sedan, 00-03, 04-06

480R  
754

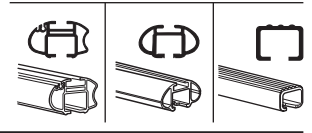
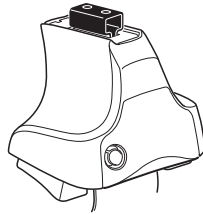

480

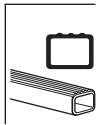
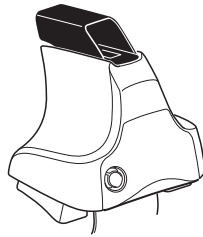

750

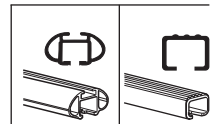
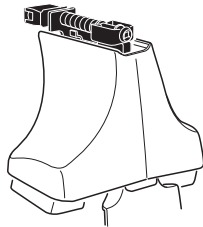

**Kit**

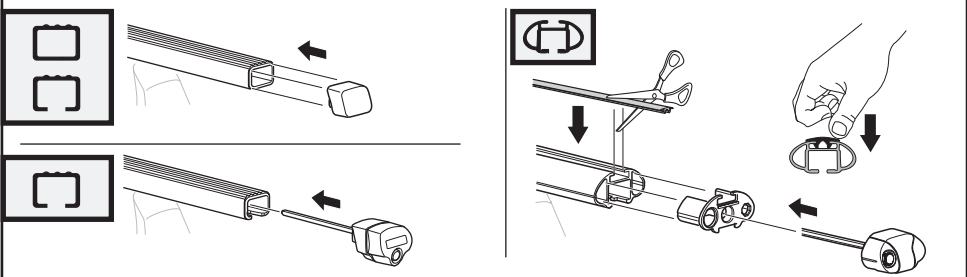
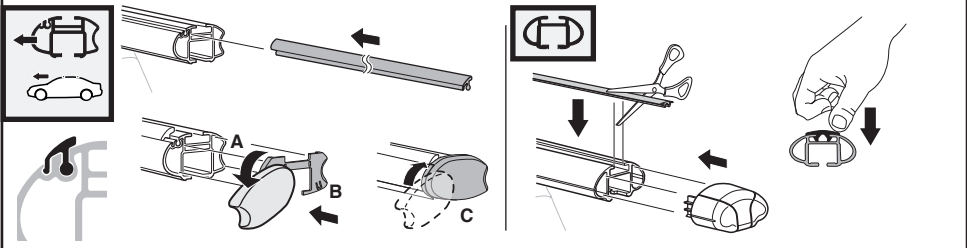

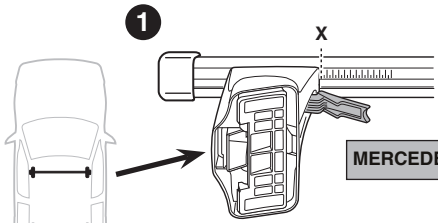
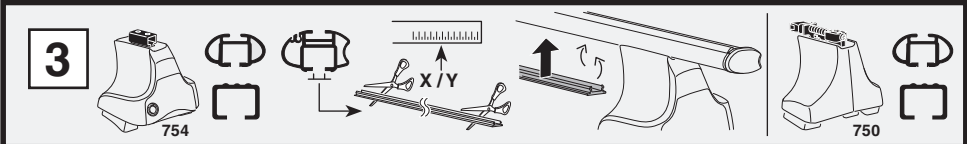

	X
MERCEDES C-Klasse, 4-dr Sedan, 00-03, 04-06	38

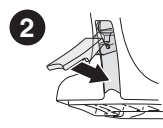
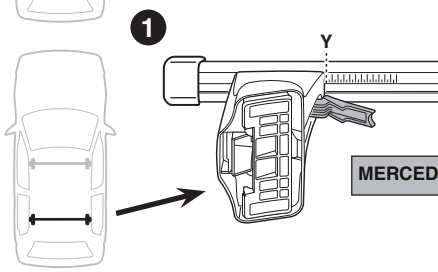

	Y
MERCEDES C-Klasse, 4-dr Sedan, 00-03, 04-06	32,5

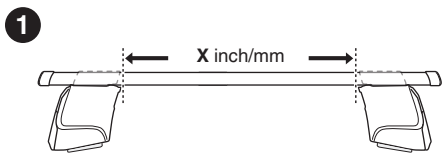
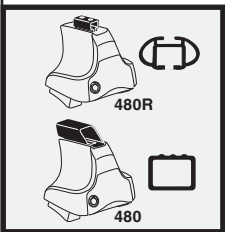

	X inch	X mm
MERCEDES C-Klasse, 4-dr Sedan, 00-03, 04-06	40 5/8"	1031 mm

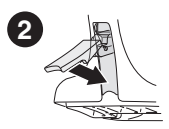
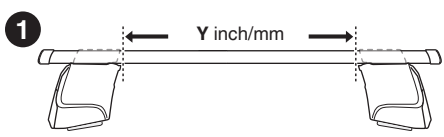

	Y inch	Y mm
MERCEDES C-Klasse, 4-dr Sedan, 00-03, 04-06	38 3/8"	976 mm

4

MERCEDES C-Klasse, 4-dr Sedan, 00-03, 04-06

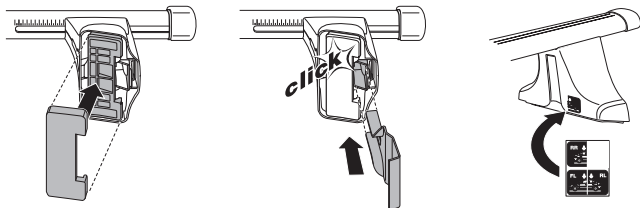
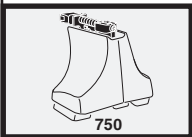
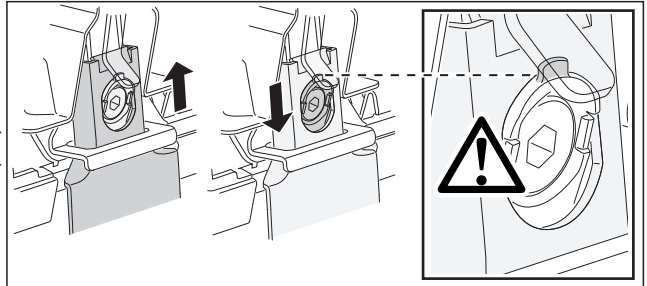
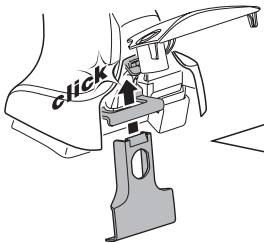
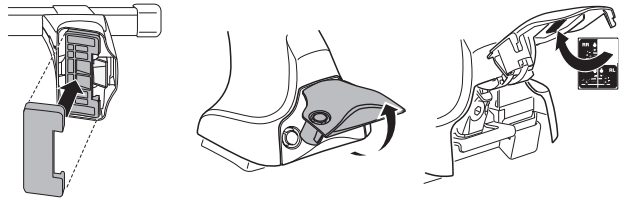
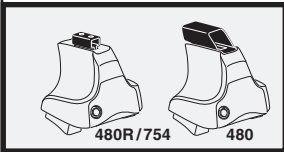
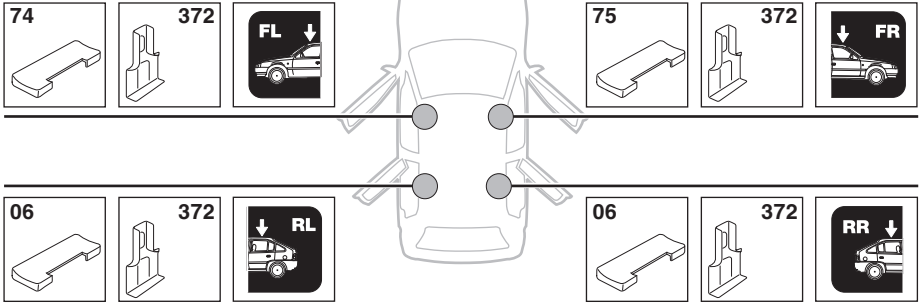

5

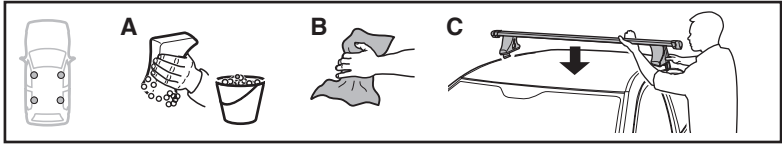

	X mm	Y mm	X inch	Y inch
<b>MERCEDES C-Klasse, 4-dr Sedan, 00-03, 04-06</b>	<b>130 mm</b>	<b>640 mm</b>	<b>5 1/8"</b>	<b>25 1/4"</b>

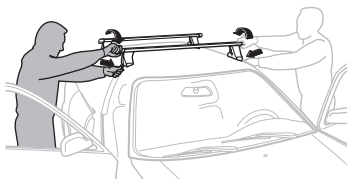
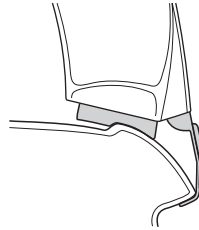
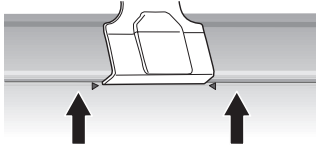
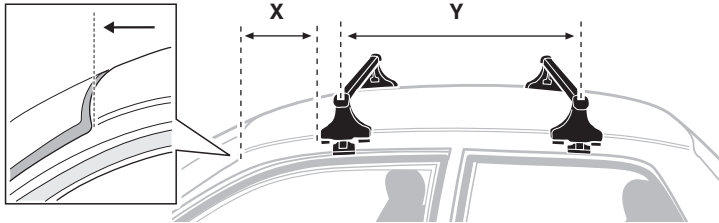

**GB/US** Tighten alternately

**D** Die Schrauben abwechselnd anziehen

**F** Serrer alternativement chaque côté

**NL** Afwisselend aan de linker- en de rechterkant aandraaien

**I** Alternare il serraggio delle viti

**E** Serrare alternativamente

**PT** Aperte alternadamente

**S** Dra åt växelvis

**FIN** Kierrä vuorotellen

**EST** Pinguldage vaheldumisi

**LAT** Pielieciet pamišus

**LIT** Užsukinėkite pakaitomis

**PL** Śruby dokręcaj naprzemiennie

**RU** Затягивайте попеременно

**CZ** Pokręťta bagażníka dokręcaj dokręcaj naprzemiennie.

**SK** Doťahujte striedavo

**SLO** Privijajte izmenično.

**HR** Naizmjenično zategnite

**HU** Egymástól függetlenül szorítandó

**GR** Σφιγγετε εναλλάξ

**TR** Dönüşümlü sıkın

**中文** 交替拧紧

**한국어** 번갈아 가며 조이십시오.

**日本語** 交互に締め付けてください。

**ไทย** ชันโนแบบสลับ

6



480R/754



480

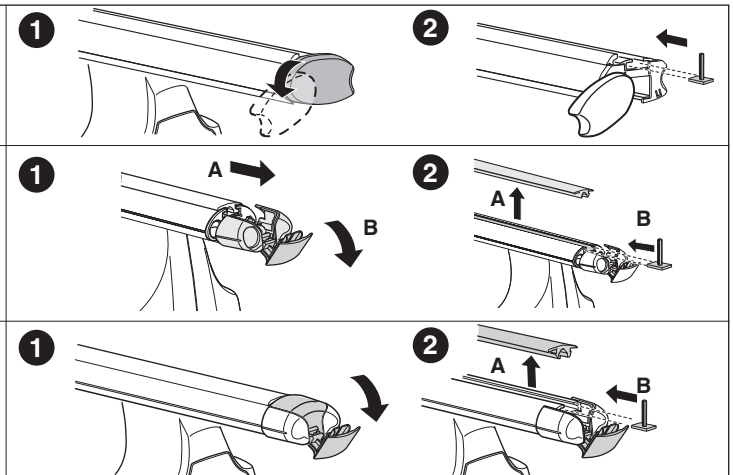
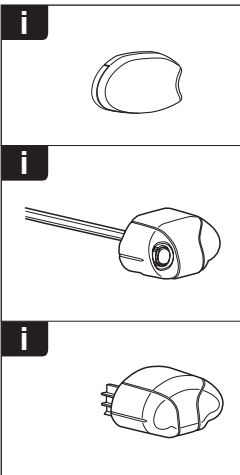
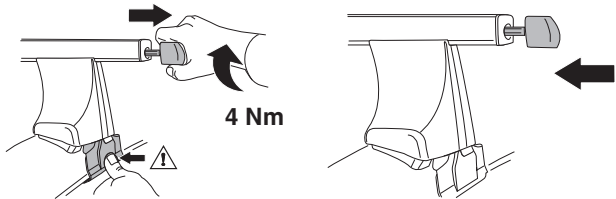
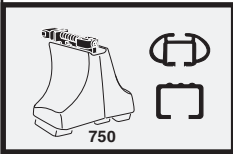
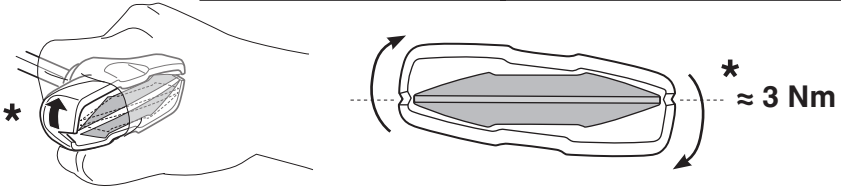
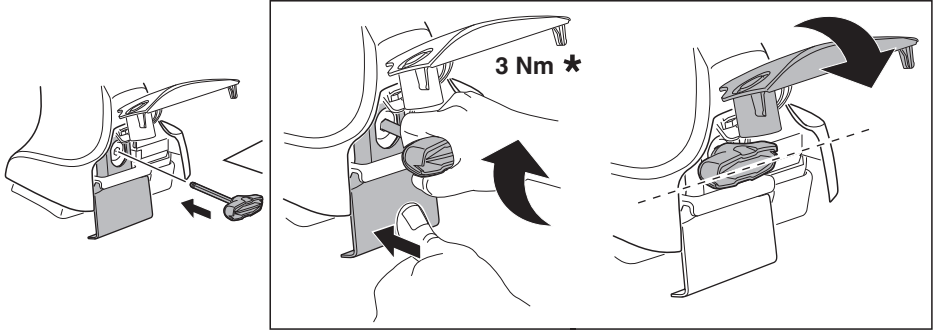

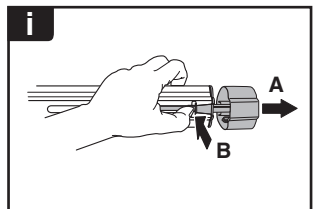
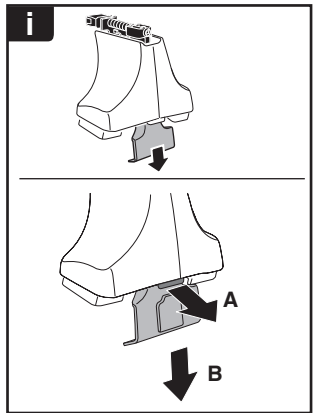
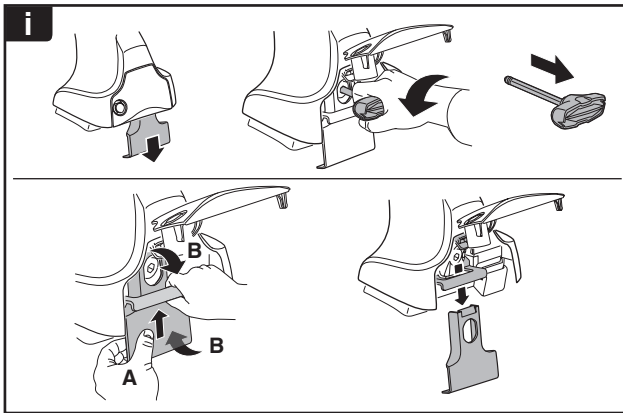
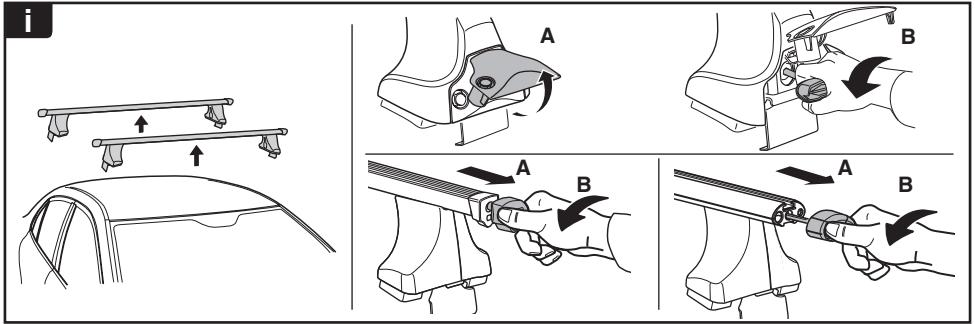

**THULE**  
SWEDEN  
**ONE  
KEY  
SYSTEM**

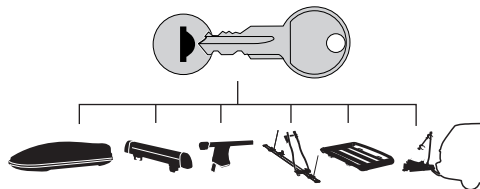

		544	(x4)
		596	(x6)
		588	(x8)
NA		510	(x10)
EUR		452	(x12)
ASIA			

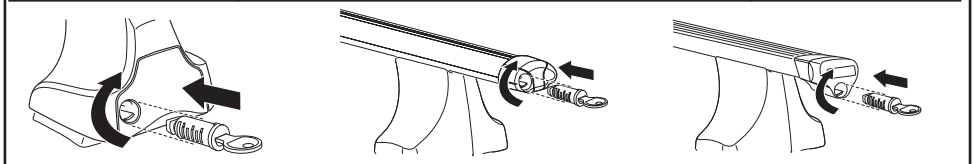

WW ▶ Thule Sweden AB, Box 69, 330 33 Hillerstorp, SWEDEN  
NA ▶ Thule Inc., 42 Silvermine Road, Seymour, Connecticut 06483, USA

info@thule.com  
customer.service@thule.com

www.thule.com