

Kit 1325

BMW 5-serie, 4-dr Sedan, 04–

BMW 5-serie, 5-dr Touring, 04– (without railing)

480R
754

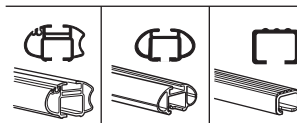
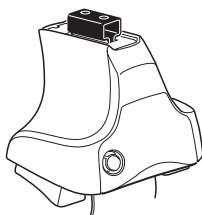

480

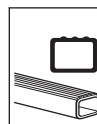
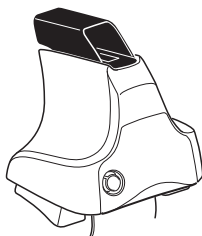

750

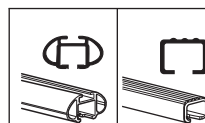
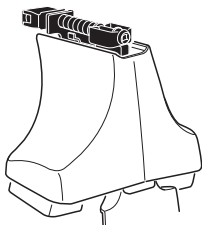

THULE[®]
SWEDEN

Kit

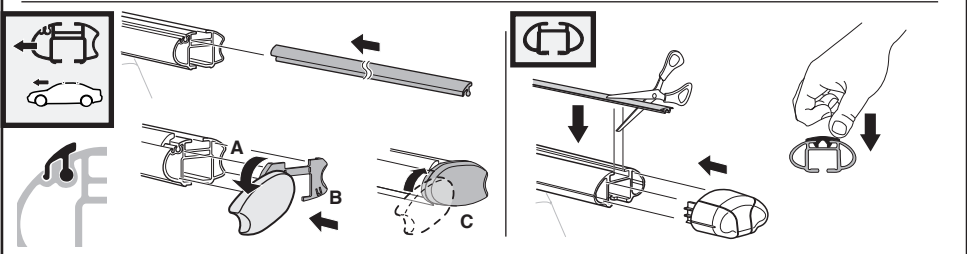
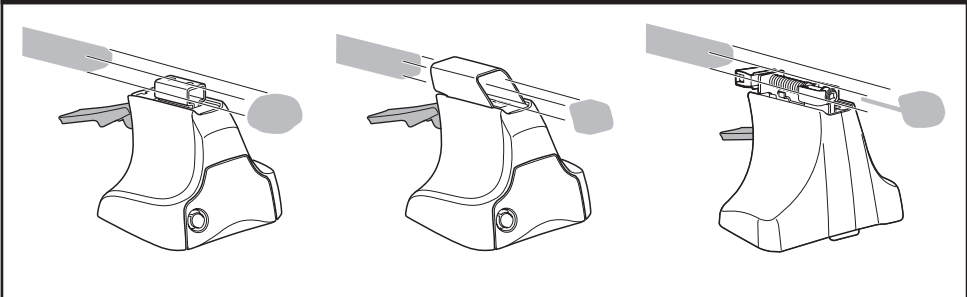

3

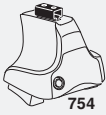

754

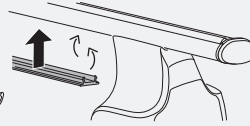
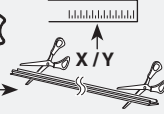

750

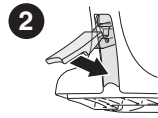
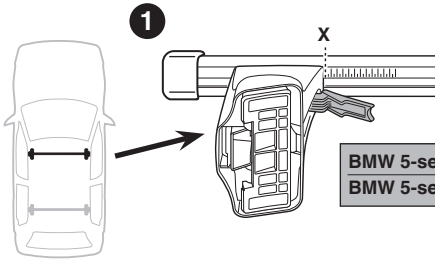

	X
BMW 5-serie, 4-dr Sedan, 04-	36,5
BMW 5-serie, 5-dr Touring, 04- (without railing)	36,5

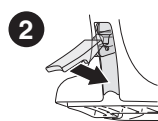
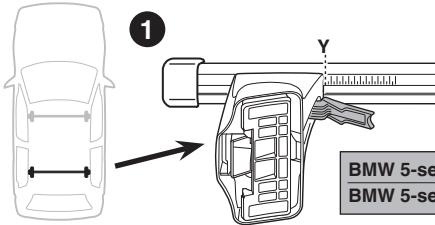

	Y
BMW 5-serie, 4-dr Sedan, 04-	36
BMW 5-serie, 5-dr Touring, 04- (without railing)	34

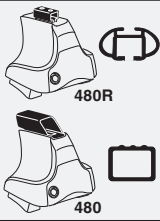

480R



480

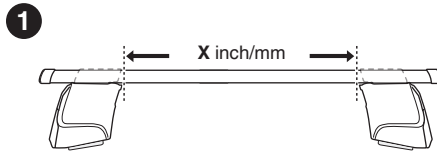

	X inch	X mm
BMW 5-serie, 4-dr Sedan, 04-	40"	1016 mm
BMW 5-serie, 5-dr Touring, 04- (without railing)	40"	1016 mm

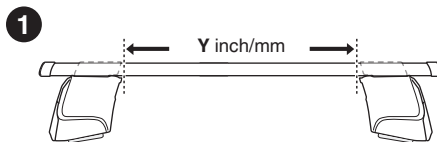
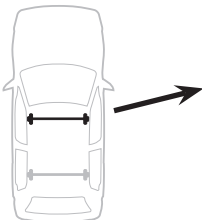

	Y inch	Y mm
BMW 5-serie, 4-dr Sedan, 04-	39 ³ / ₄ "	1011 mm
BMW 5-serie, 5-dr Touring, 04- (without railing)	39"	991 mm

4

BMW 5-serie, 4-dr Sedan, 04–
BMW 5-serie, 5-dr Touring, 04– (without railing)

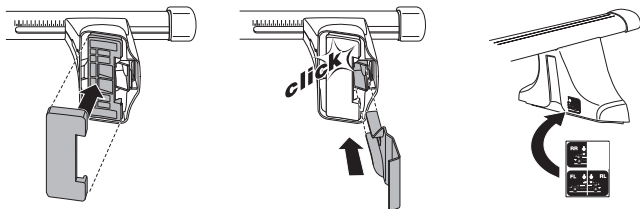
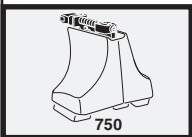
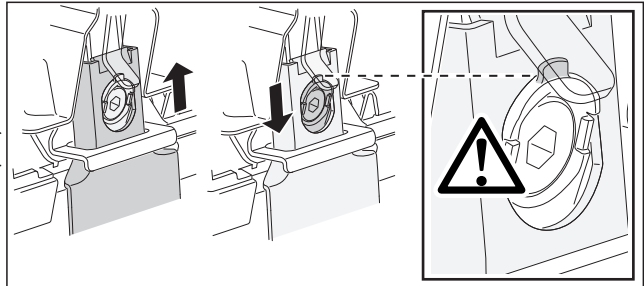
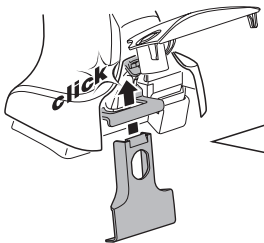
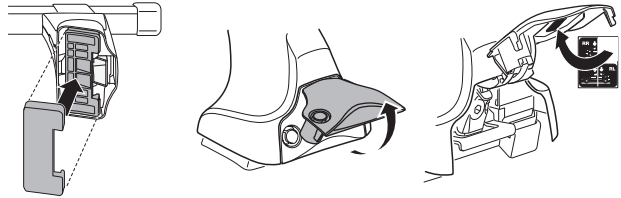
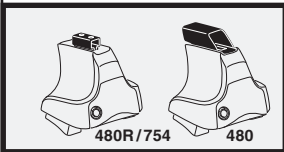
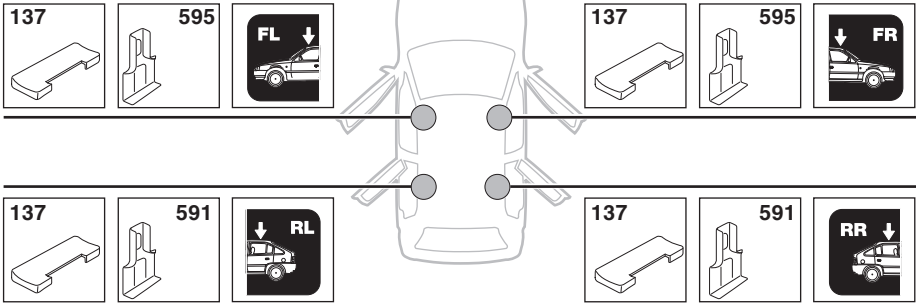

5

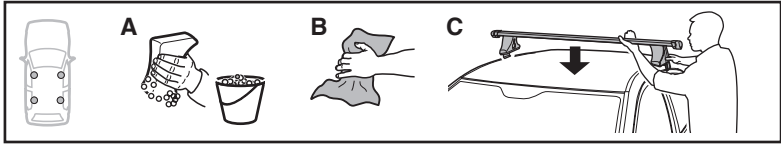

	X mm	Y mm	X inch	Y inch
BMW 5-serie, 4-dr Sedan, 04–	270 mm	750 mm	10 ⁵ / ₈ ”	29 ¹ / ₂ ”
BMW 5-serie, 5-dr Touring, 04– (without railing)	270 mm	700 mm	10 ⁵ / ₈ ”	27 ¹ / ₂ ”

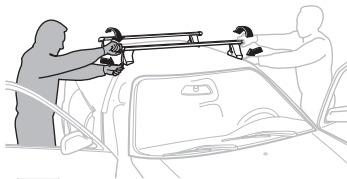
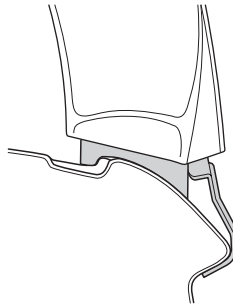
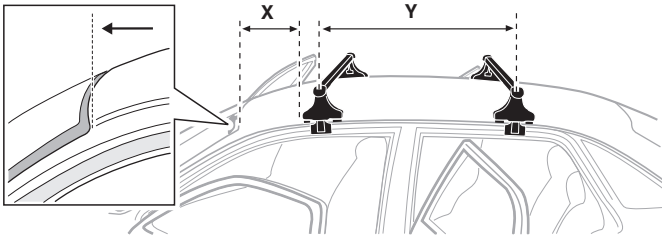

GB/US Tighten alternately

D Die Schrauben abwechselnd anziehen

F Serrer alternativement chaque côté

NL Afwisselend aan de linker- en de rechterkant aandraaien

I Alternare il serraggio delle viti

E Serrare alternativamente

PT Aperte alternadamente

S Dra åt växelvís

FIN Kierrä vuorotellen

EST Pinguldage vaheldumisi

LAT Pielieciet pamišus

LIT Užsukinėkite pakaitomis

PL Śruby dokręcaj naprzemiennie

RU Затягивайте попеременно

CZ Pokręťta bagażníka dokręcaj dokręcaj naprzemiennie.

SK Doťahujte striedavo

SLO Privijajte izmenično.

HR Naizmjenično zategnite

HU Egymástól függetlenül szorítandó

GR Σφιγγετε εναλλάξ

TR Dönüşümlü sıkın

中文 交替拧紧

한국어 번갈아 가며 조이십시오.

日本語 交互に締め付けてください。

ไทย ชั้้นโน้แบบสลับ

6



480R/754



480

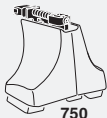
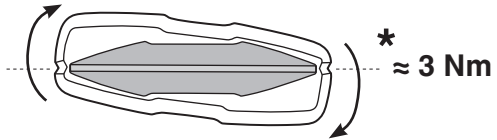
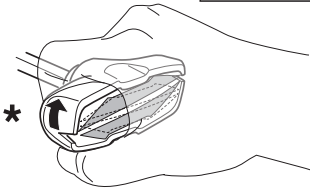
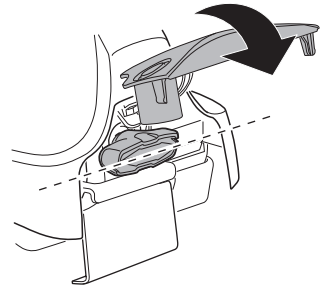
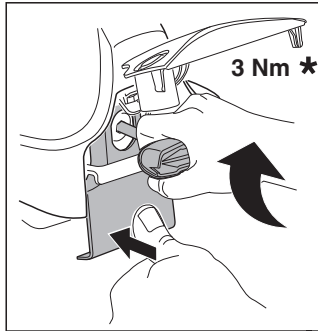
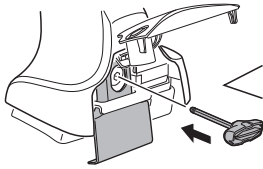

750

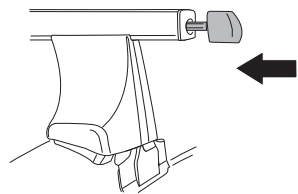
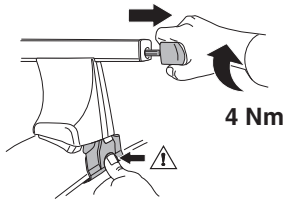

i



1

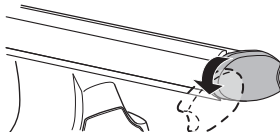

2

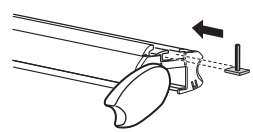

i

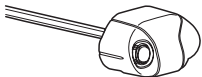

1

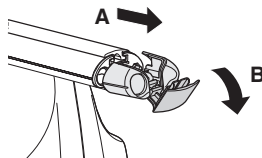

2

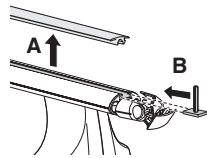

i



1

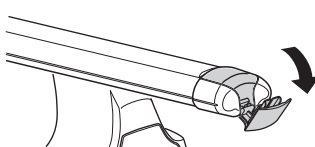

2

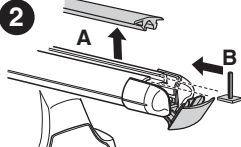

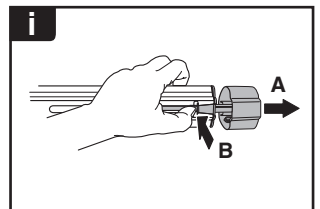
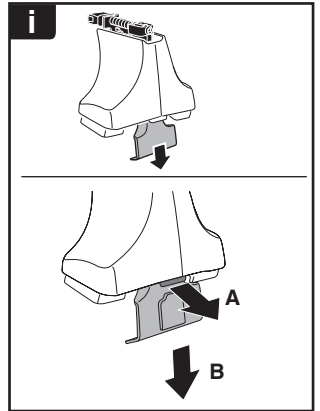
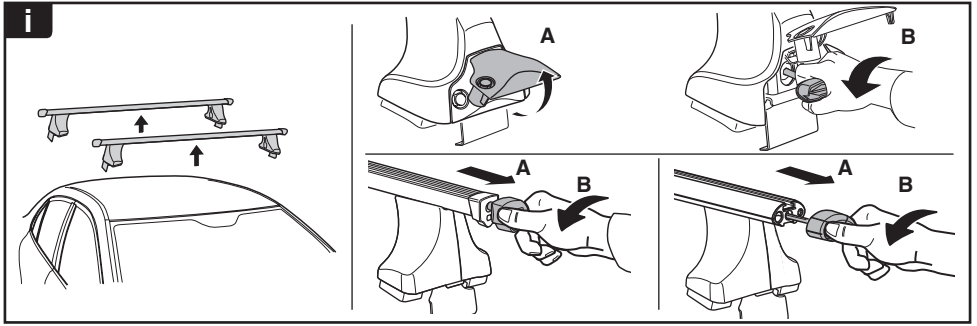

THULE
SWEDEN
**ONE
KEY
SYSTEM**



- 544 (x4)
- 596 (x6)
- 588 (x8)
- NA 510 (x10)
- EUR 452 (x12)
- ASIA 452 (x12)

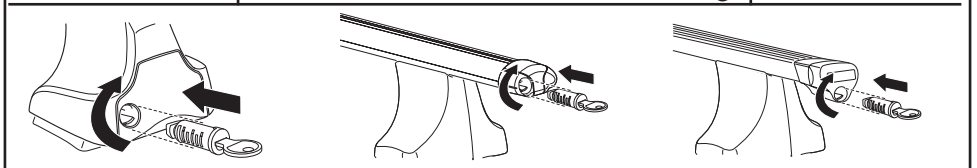

WW ▶ Thule Sweden AB, Box 69, 330 33 Hillerstorp, SWEDEN
NA ▶ Thule Inc., 42 Silvermine Road, Seymour, Connecticut 06483, USA

info@thule.com
customer.service@thule.com

www.thule.com