

Kit 1454

NISSAN Dualis, 5-dr SUV, 07–
NISSAN Qashqai, 5-dr SUV, 07–

480R
754

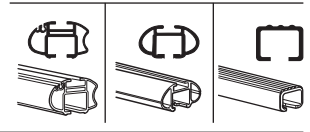
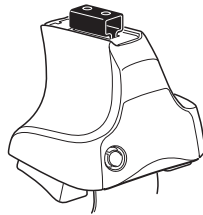

480

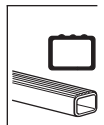
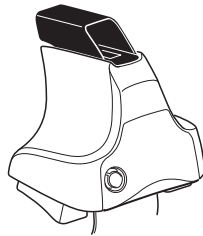

750

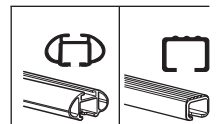
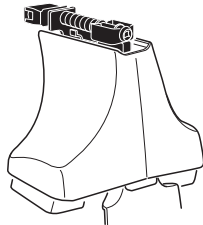

THULE[®]
SWEDEN

ISO 11154-E

x2 x2 x2 x4	x2	x2 x2 x4 x4	x2 x2	x2	x2

Kit

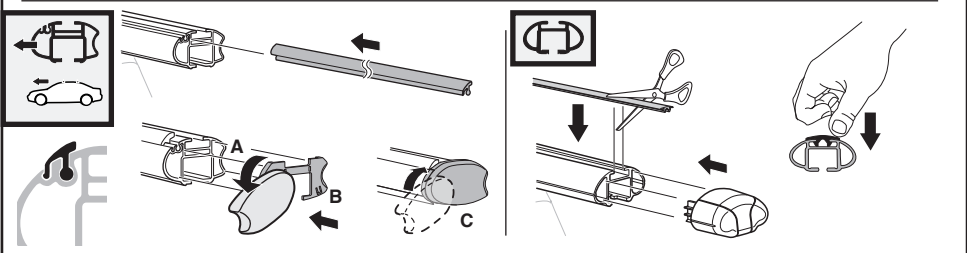
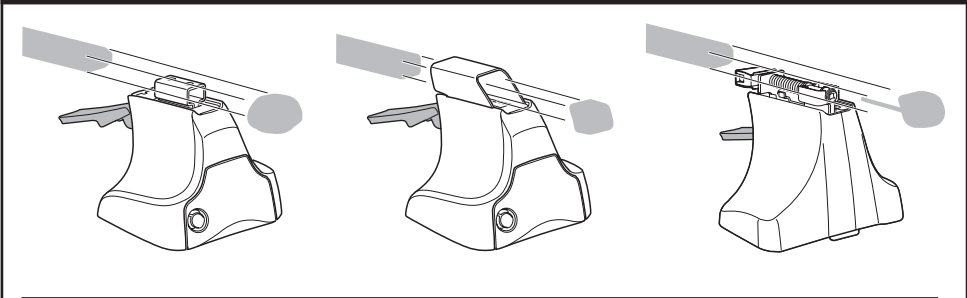

3

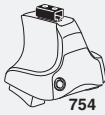

754

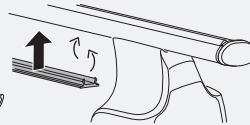
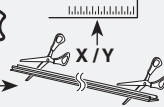

750



1

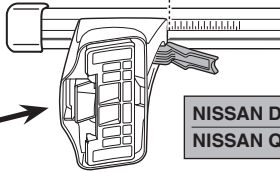
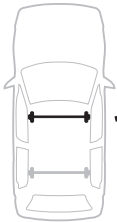

2

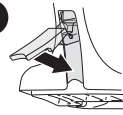

	X
NISSAN Dualis, 5-dr SUV, 07-	43,5
NISSAN Qashqai, 5-dr SUV, 07-	43,5

1

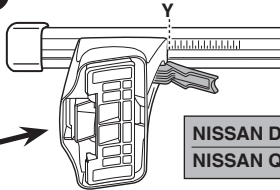
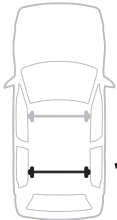

2

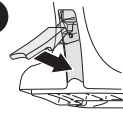

	Y
NISSAN Dualis, 5-dr SUV, 07-	40,5
NISSAN Qashqai, 5-dr SUV, 07-	40,5



480R



480

1

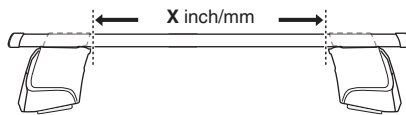

2

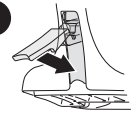

	X inch	X mm
NISSAN Dualis, 5-dr SUV, 07-	42 ³ / ₄ "	1086 mm
NISSAN Qashqai, 5-dr SUV, 07-	42 ³ / ₄ "	1086 mm

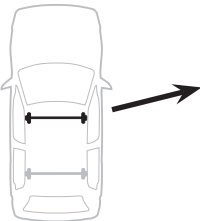

1

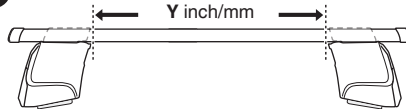

2

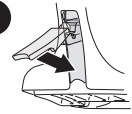

	Y inch	Y mm
NISSAN Dualis, 5-dr SUV, 07-	41 ⁵ / ₈ "	1056 mm
NISSAN Qashqai, 5-dr SUV, 07-	41 ⁵ / ₈ "	1056 mm

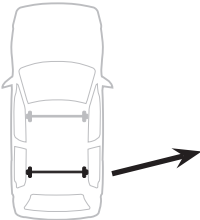

4

NISSAN Dualis, 5-dr SUV, 07-
NISSAN Qashqai, 5-dr SUV, 07-

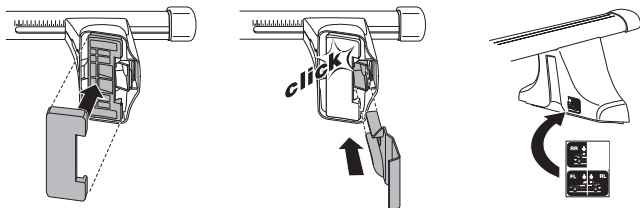
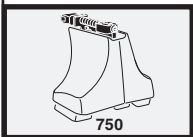
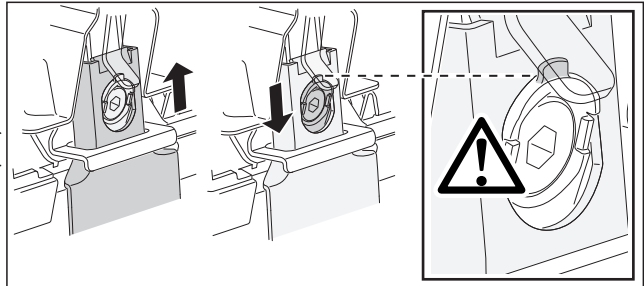
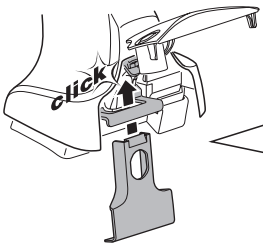
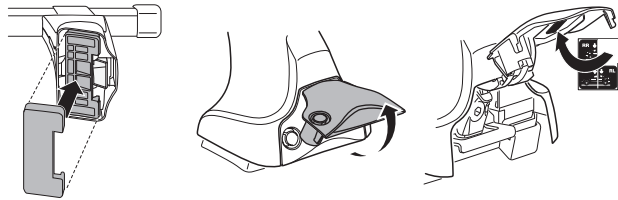
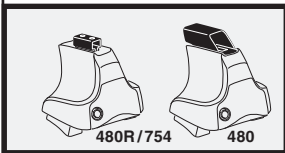
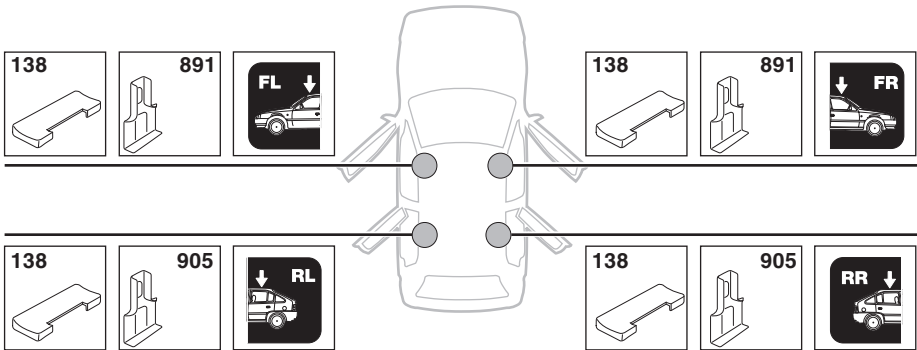

5

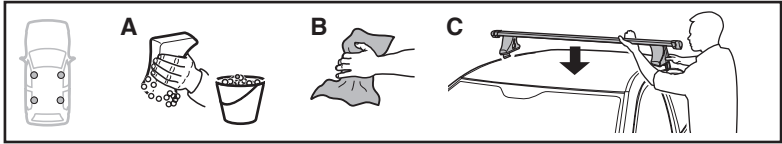

	X mm	Y mm	X inch	Y inch
NISSAN Dualis, 5-dr SUV, 07-	370 mm	770 mm	14 ⁵ / ₈ "	30 ³ / ₈ "
NISSAN Qashqai, 5-dr SUV, 07-	370 mm	770 mm	14 ⁵ / ₈ "	30 ³ / ₈ "

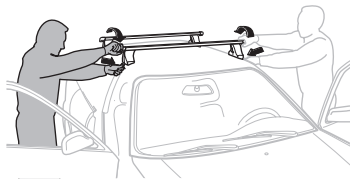
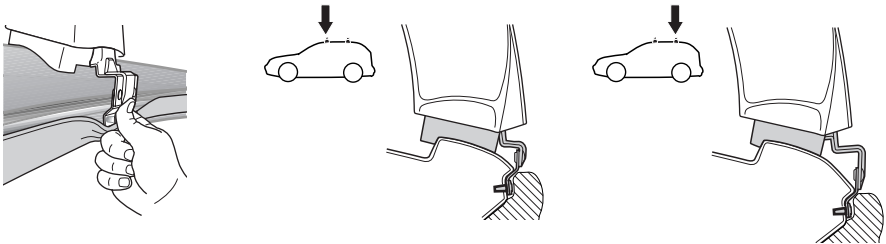
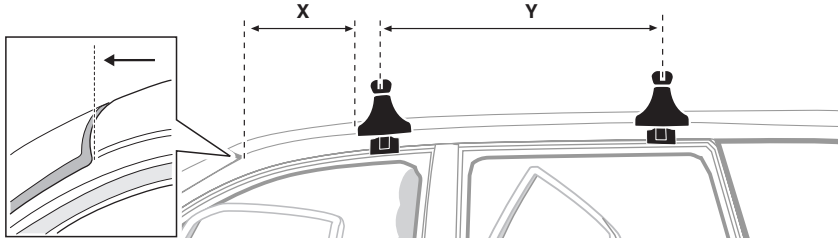

GB/US Tighten alternately

D Die Schrauben abwechselnd anziehen

F Serrer alternativement chaque côté

NL Afwisselend aan de linker- en de rechterkant aandraaien

I Alternare il serraggio delle viti

E Serrare alternativamente

PT Aperte alternadamente

S Dra åt växelvis

FIN Kierrä vuorotellen

EST Pinguldage vaheldumisi

LAT Pielvelciēt pamīšus

LIT Užsukinėkite pakaitomis

PL Śruby dokręcaj naprzemiennie

RU Затягивайте попеременно

CZ Pokręťta bagažníka dokręcaj dokręcaj naprzemiennie.

SK Doťahujte striedavo

SLO Privijajte izmenično.

HR Naizmjenično zategnite

HU Egymástól függetlenül szorítandó

GR Σφίγγετε εναλλάξ

TR Dönüşümlü sıkın

中文 交替拧紧

한국어 번갈아 가며 조이십시오.

日本語 交互に締め付けてください。

ไทย ชั้้นโน้บแบบสลับ

6



480R/754



480

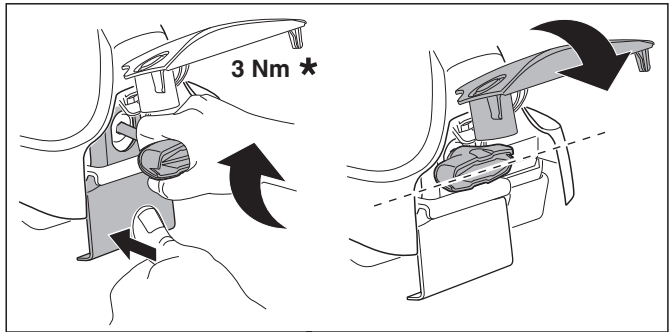
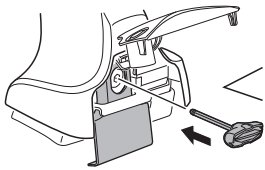

3 Nm *

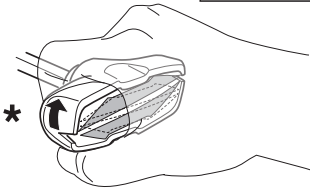

*

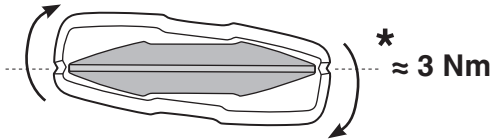

* ≈ 3 Nm



750

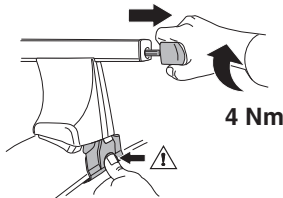

4 Nm

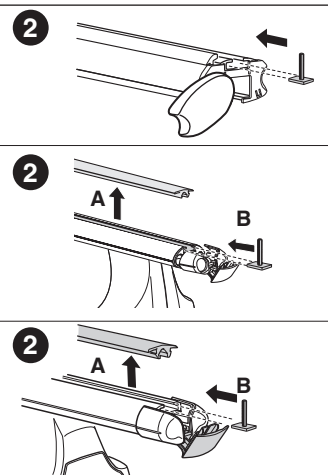
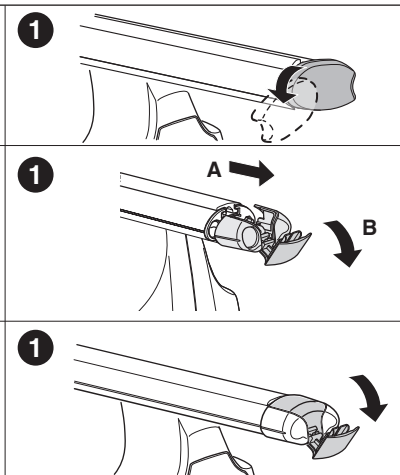
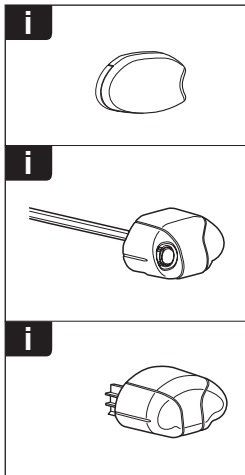
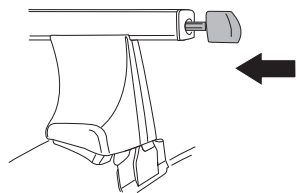

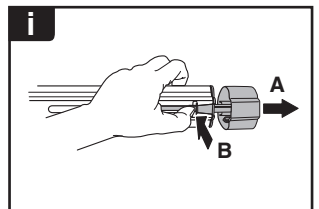
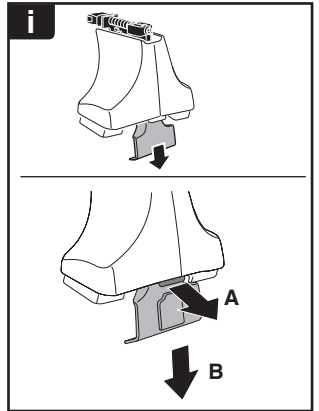
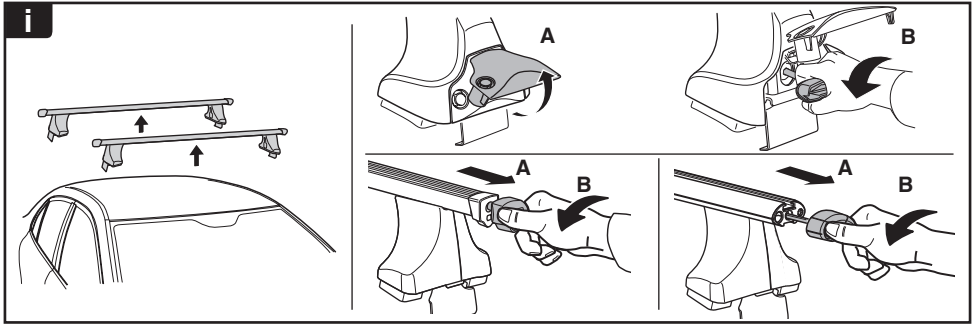

THULE
SWEDEN
**ONE
KEY
SYSTEM**



- 544 (x4)
- 596 (x6)
- 588 (x8)
- NA 510 (x10)
- EUR 452 (x12)
- ASIA

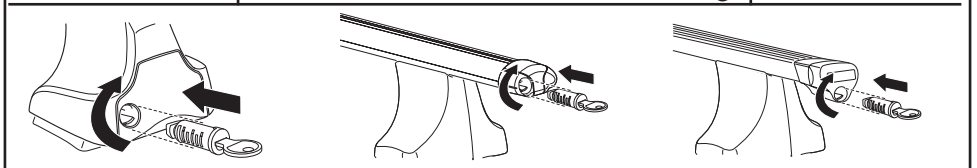

WW ▶ Thule Sweden AB, Box 69, 330 33 Hillerstorp, SWEDEN
NA ▶ Thule Inc., 42 Silvermine Road, Seymour, Connecticut 06483, USA

info@thule.com
customer.service@thule.com

www.thule.com