

# Kit 4017

MITSUBISHI ASX, 5-dr SUV, 10-

This kit is only for vehicles with flush or integrated side railing.



460R  
753

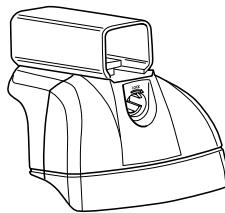

460



**Kit**



753



x4



x4



x4



16 mm

x8



5 mm

x1



x4



x1

460R

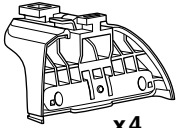

x4



x4



x4



16 mm

x8



5 mm

x1



x4

460

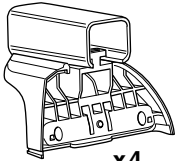

x4



x4



x4



16 mm

x8



5 mm

x1



x4

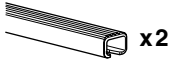

x2



x2

23 mm



x2

17 mm



x2

23 mm

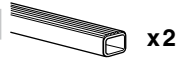

x2

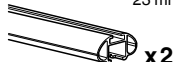

x2

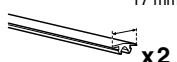

x2

23 mm

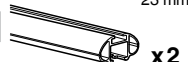

x2



x4



x2



x4



x4

1



753/460R



460

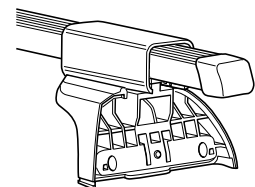
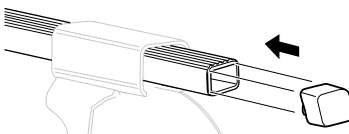
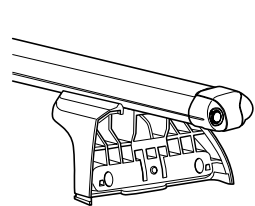
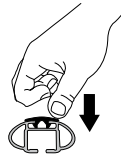
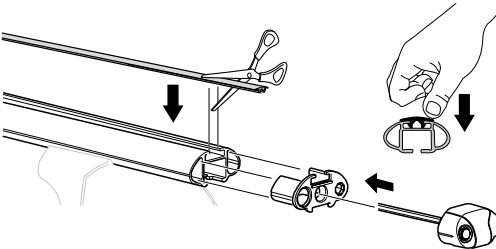
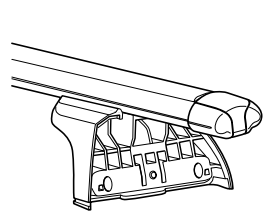
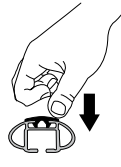
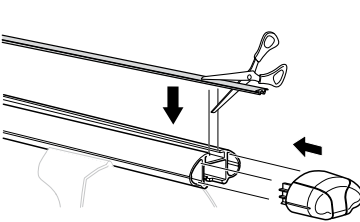
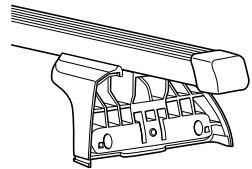
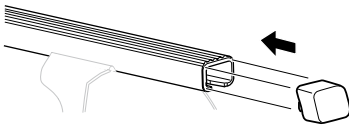
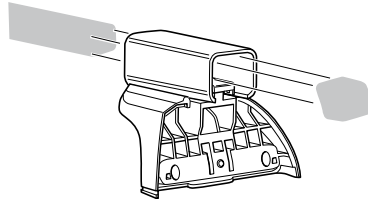
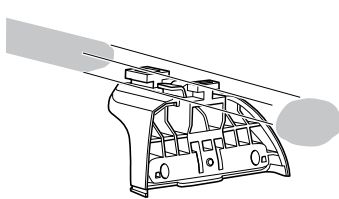

2

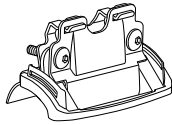

x 4



x 1

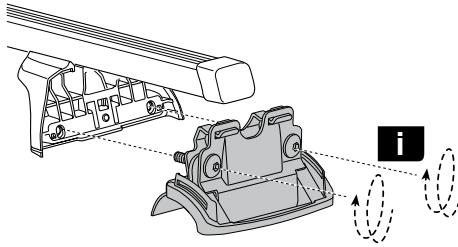
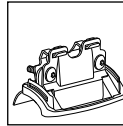
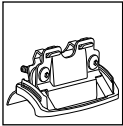
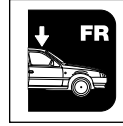
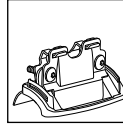
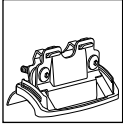

**i**

**GB** Only a few turns

**D** Nur wenige Umdrehungen

**F** Quelques tours uniquement

**NL** Slechts enkele slagen

**I** Solo qualche giro

**E** Sólo algunas vueltas

**PT** Noções básicas

**S** Endast några varv

**FIN** Vain muutama kierros

**EST** Ainult mõni pööre

**LAT** Tikai dažī apgriezieni

**LIT** Tik keli pasukimai

**PL** Wystarczy kilka obrotów

**RU** Достаточно нескольких оборотов

**CZ** Pouze několik otáček

**SK** Len niekoľko otáčok

**SLO** Le nekaj obratov

**HR** Samo nekoliko okreta

**HU** Csak néhány fordítás

**GR** Μόνο μερικές στροφές

**TR** Yalnız birkaç kez çevirm

**中文** 只有几个转向

**한국어** 두 세번만

**日本語** 数回転のみ

**ไทย** หมุนเพียงไม่กี่รอบ

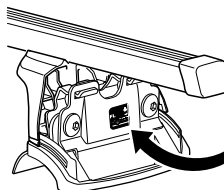

**3**

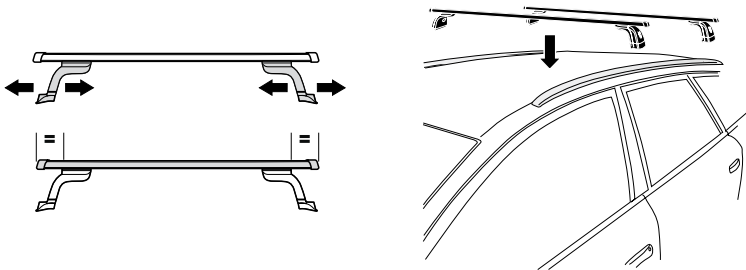

**A**

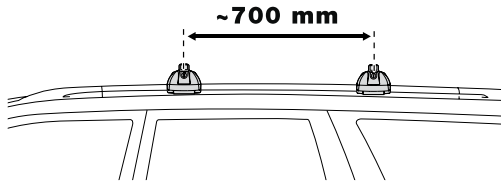

**B**

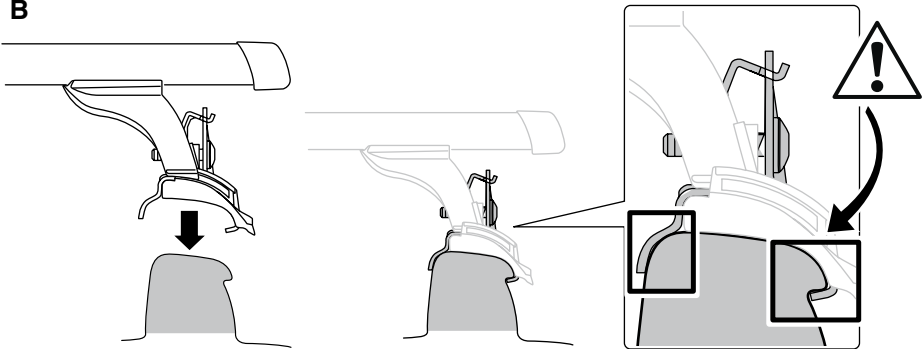

**C**

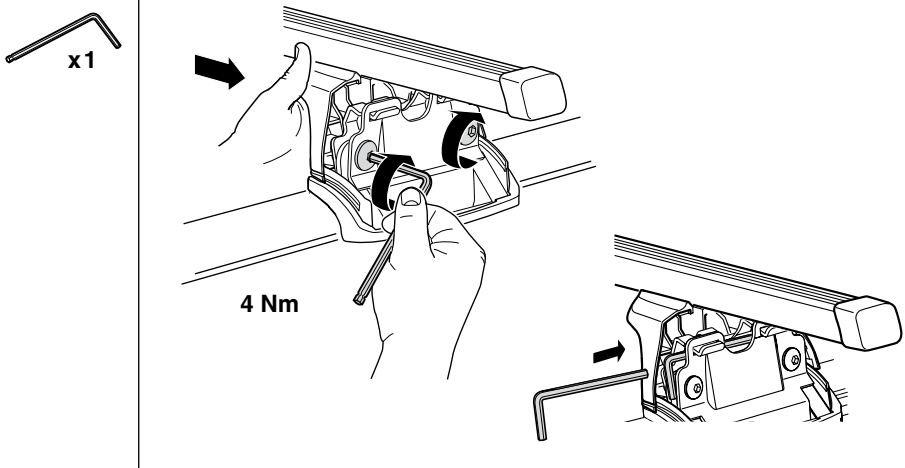

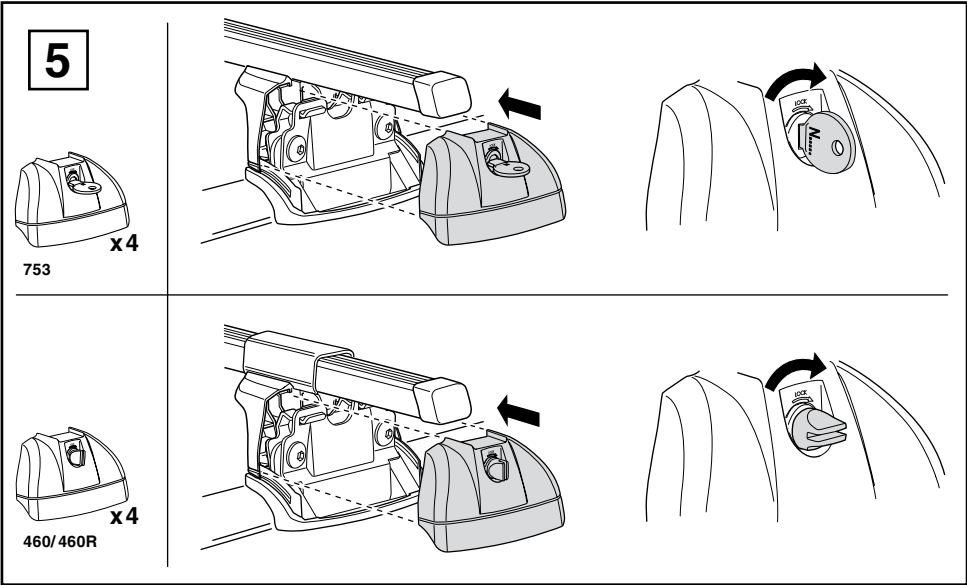
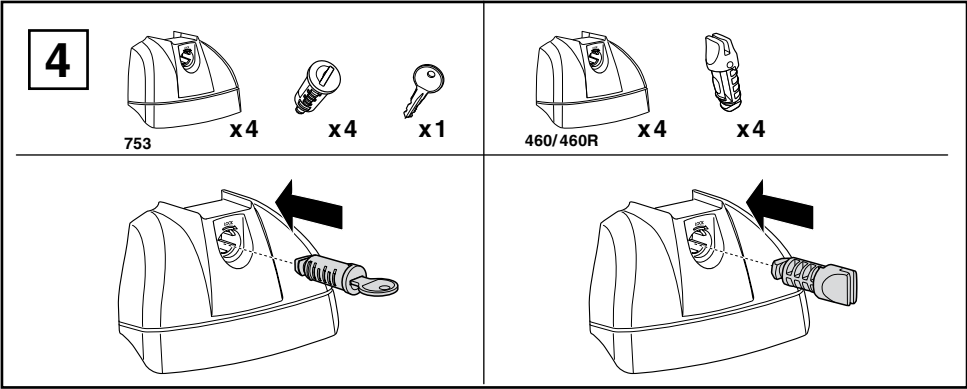



- 544 (x4)
- 596 (x6)
- 588 (x8)
- NA 510 (x10)
- EUR ASIA 452 (x12)

WW ▶ Thule Sweden AB, Box 69, 330 33 Hillerstorp, SWEDEN  
 NA ▶ Thule Inc., 42 Silvermine Road, Seymour, Connecticut 06483, USA

info@thule.com  
 customer.service@thule.com

www.thule.com