

Kit 4031

KIA Ceed SW, 5-dr Estate, 12-

This kit is only for vehicles with flush or integrated side railing.

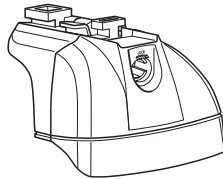

460R
753

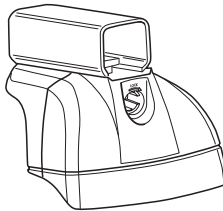
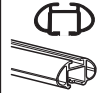

460

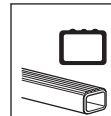

Kit

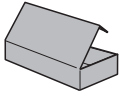

753

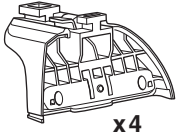

x4



x4



x4



16 mm
x8

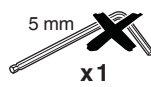

5 mm
x1



x4



x1

460R

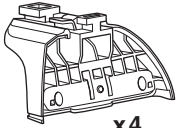

x4



x4



x4



16 mm
x8

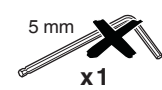

5 mm
x1



x4

460

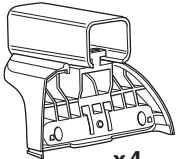

x4



x4



x4



16 mm
x8

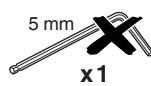

5 mm
x1



x4

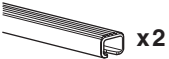
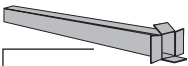

x2



x2
23 mm



x1
17 mm



x2
23 mm

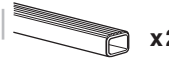

x2

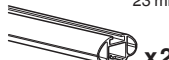

x2

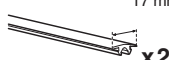

x2
23 mm

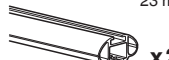

x2



x4

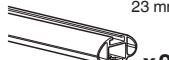

x2



x4



x4

1

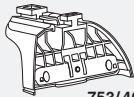

753/460R

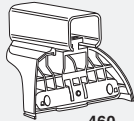

460

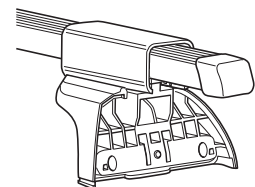
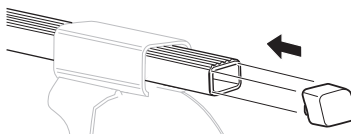
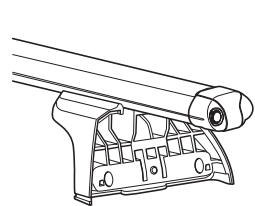
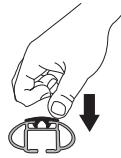
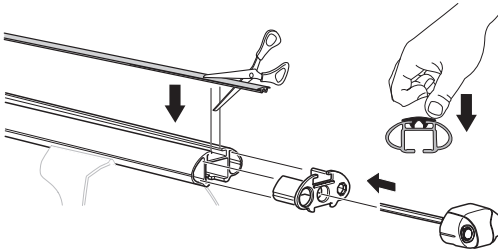
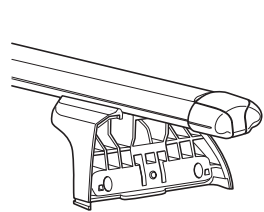
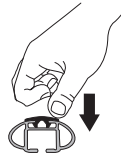
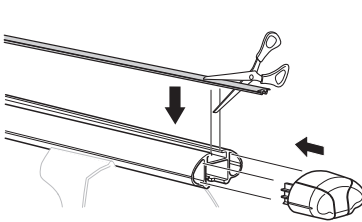
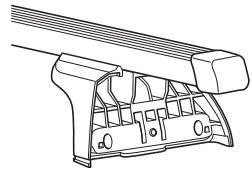
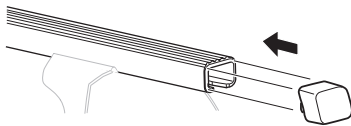
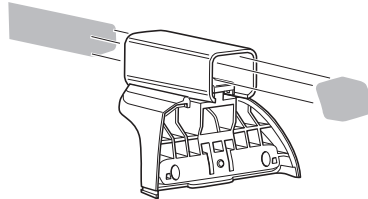
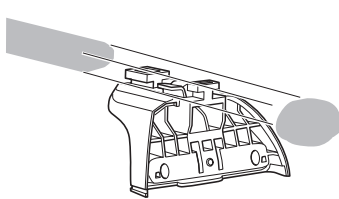

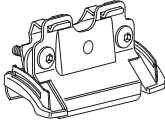
2**x 4****i**

GB	Only a few turns	EST	Ainult mõni pööre	HR	Samo nekoliko okreta
D	Nur wenige Umdrehungen	LAT	Tikai dažī apgriezieni	HU	Csak néhány fordítás
F	Quelques tours uniquement	LIT	Tik keli pasukimai	GR	Μόνο μερικές στροφές
NL	Slechts enkele slagen	PL	Wystarczy kilka obrotów	TR	Yalnız birkaç kez çevirm
I	Solo qualche giro	RU	Достаточно нескольких оборотов	中文	只有几个转向
E	Sólo algunas vueltas	CZ	Pouze několik otáček	한국어	두 세번만
PT	Noções básicas	SK	Len niekoľko otáčok	日本語	数回転のみ
S	Endast några varv	SLO	Le nekaj obratov	ไทย	หมุนเพียงไม่กี่รอบ
FIN	Vain muutama kierros				

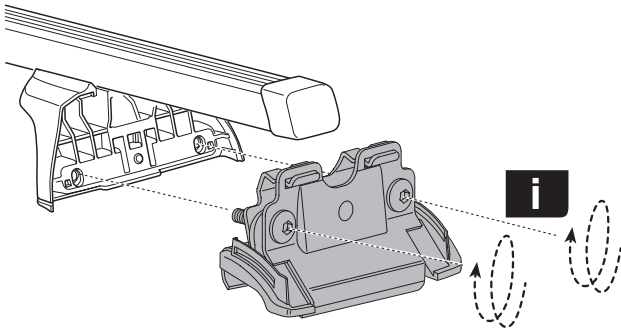
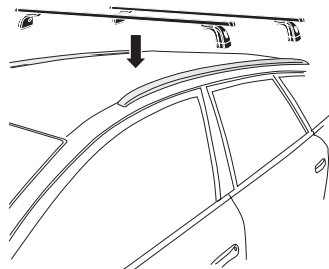
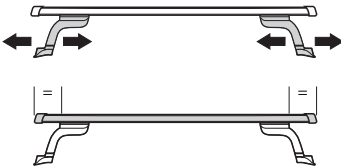
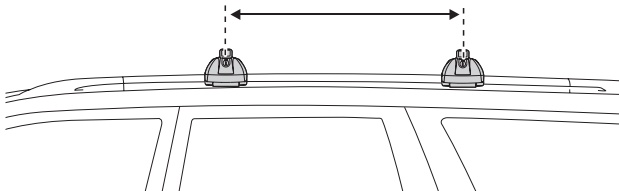
**3****~700 mm**

4

A

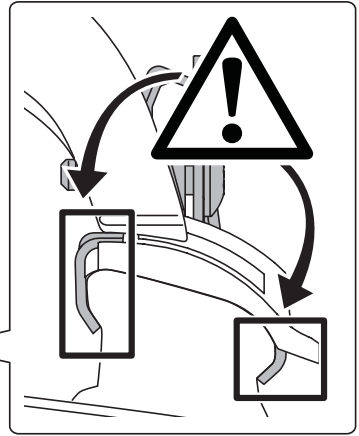
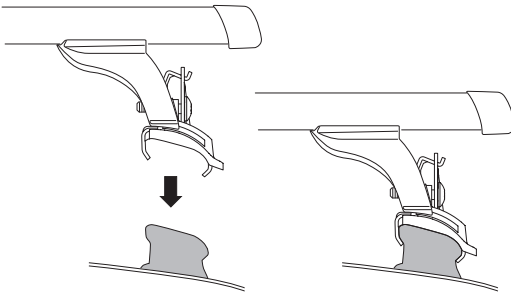

B

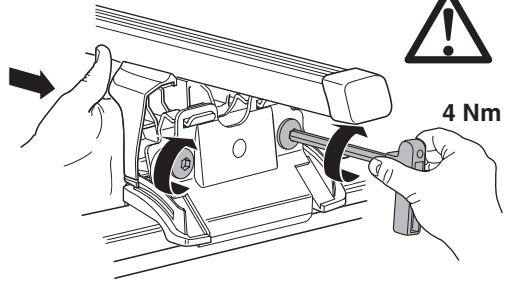
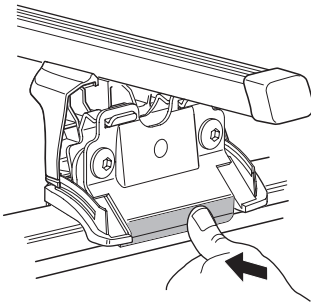
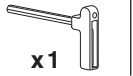

GB/US

Tighten alternately

D

Die Schrauben abwechselnd anziehen

F

Serrer alternativement chaque côté

NL

Afwisselend aan de linker- en de rechterkant aandraaien

I

Alternare il serraggio delle viti

E

Apretar alternativamente

PT

Aperte alternadamente

S

Dra åt växelvis

FIN

Kierrä vuorotellen

EST

Pinguldage vaheldumisi

LAT

Pievēlciēt pamišus

LIT

Užsukinėkite pakaitomis

PL

Śruby dokręcaj naprzemiennie

RU

Затягивайте попеременно

CZ

Pokręťte багаžníka dokręcaj dokręcaj naprzemiennie.

SK

Dotahujte striedavo

SLO

Privijajte izmenično.

HR

Naizmjenično zategnite

HU

Egymástól függetlenül szorítandó

GR

Σφιγγετε εναλλάξ

TR

Dönüşümlü sıkın

中文

交替拧紧

한국어

번갈아 가며 조이십시오.

日本語

交互に締め付けてください。

ไทย

ขันในแบบสลับ



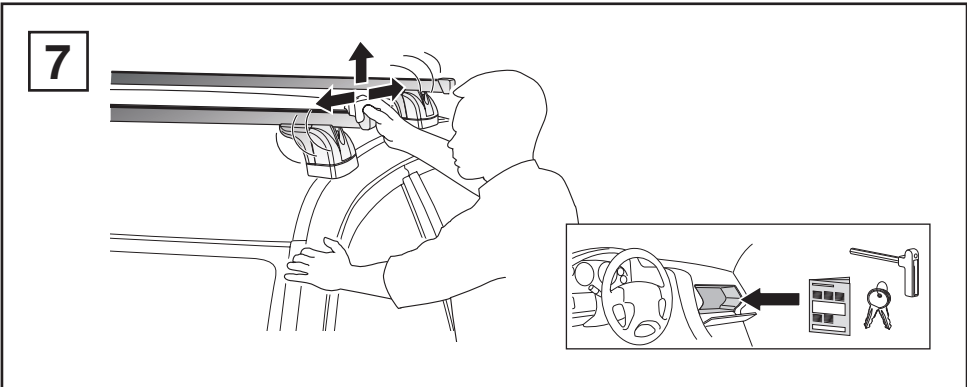
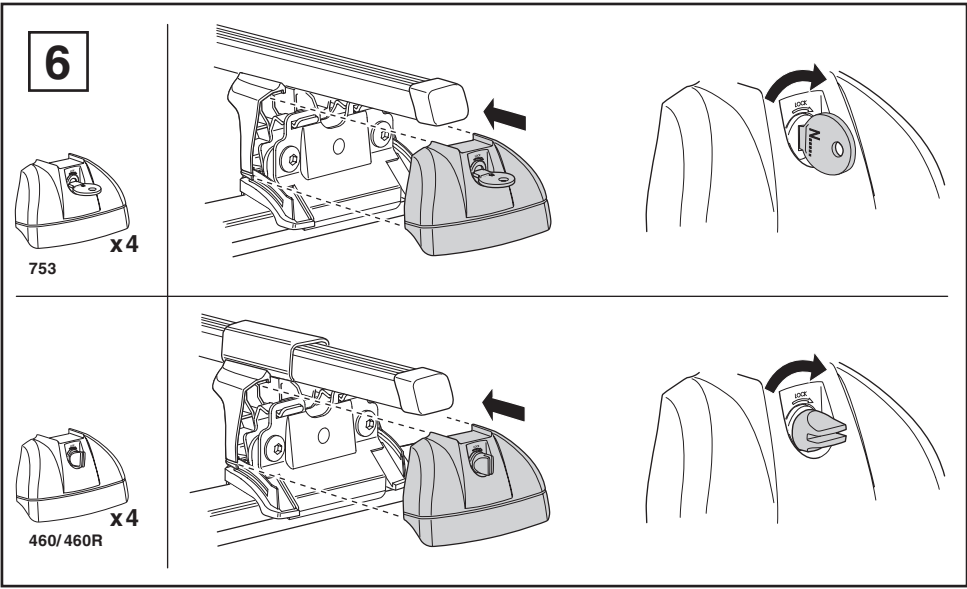
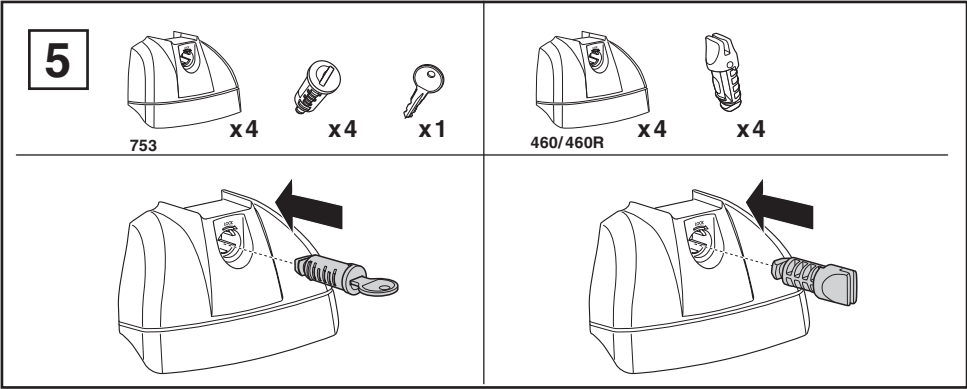

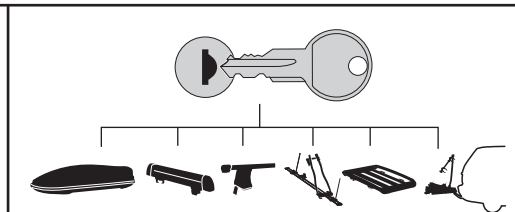
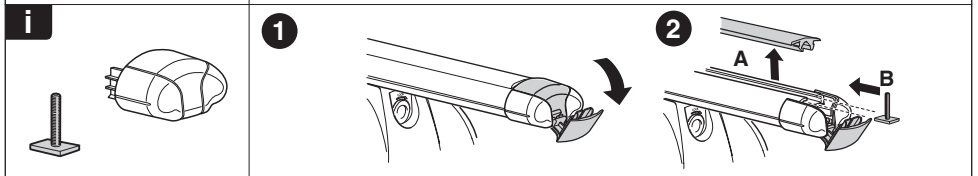
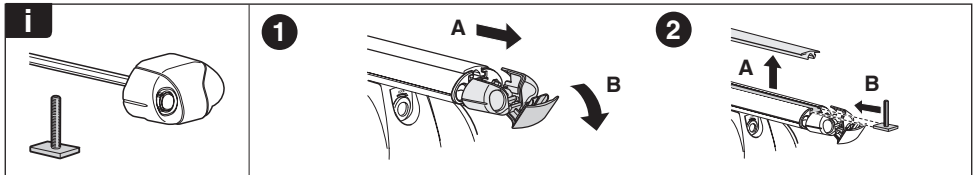
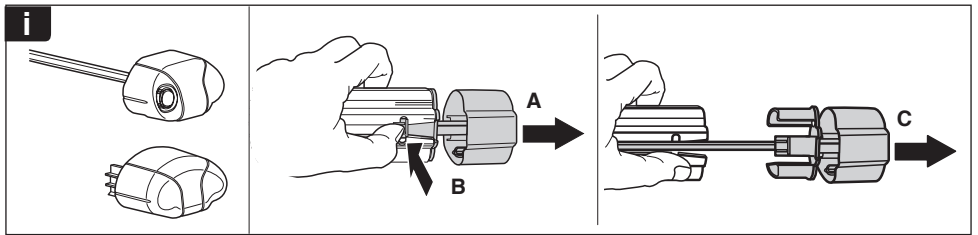
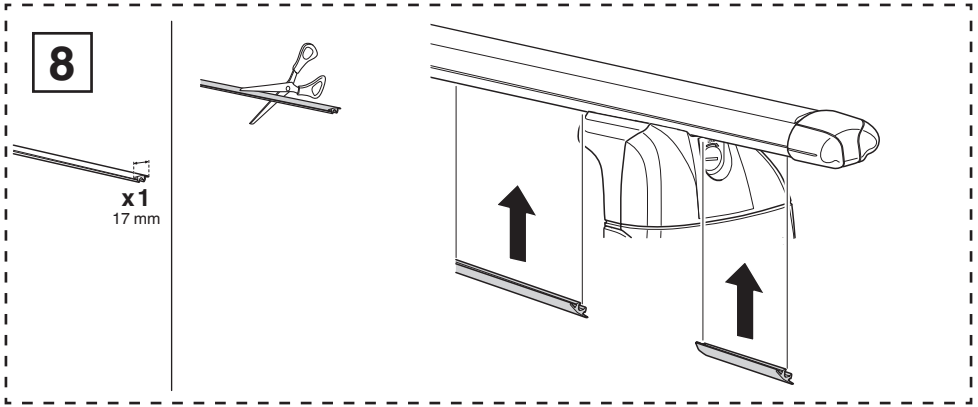

- 544 (x4)
- 596 (x6)
- 588 (x8)
- NA 510 (x10)
- EUR 452 (x12)

WW ▶ Thule Sweden AB, Box 69, 330 33 Hillerstorp, SWEDEN
 NA ▶ Thule Inc., 42 Silvermine Road, Seymour, Connecticut 06483, USA

info@thule.com
 customer.service@thule.com

www.thule.com