

# Kit 4030

MITSUBISHI Outlander, 5-dr SUV, 13-

This kit is only for vehicles with flush or integrated side railing.



460R  
753

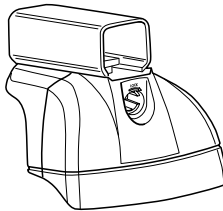

460

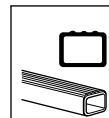

**Kit**

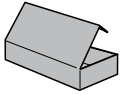

753

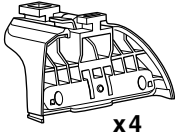

x4



x4



x4



16 mm

x8

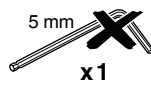

5 mm

x1



x4



x1

460R

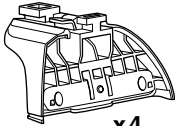

x4



x4



x4



16 mm

x8

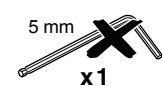

5 mm

x1



x4

460

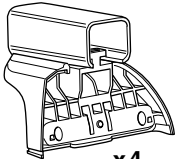

x4



x4



x4



16 mm

x8

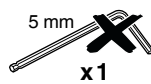

5 mm

x1



x4

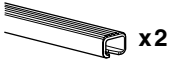
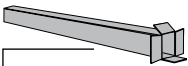

x2



x2

23 mm



x1

17 mm



x2

23 mm

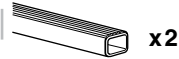

x2

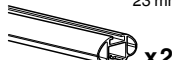

x2

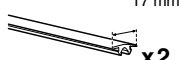

x2

23 mm

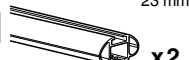

x2



x4

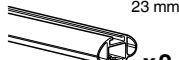

x2



x4



x4

1

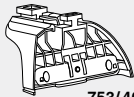

753/460R

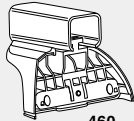

460

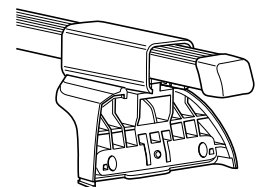
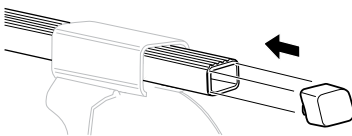
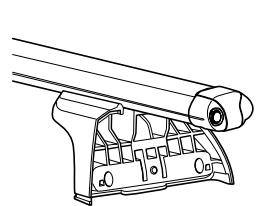
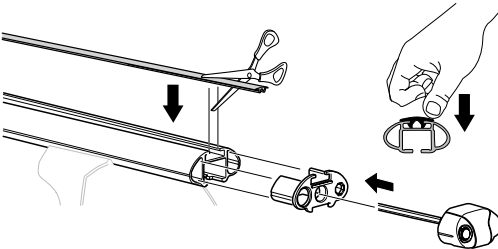
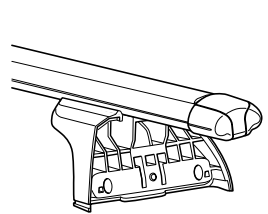
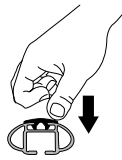
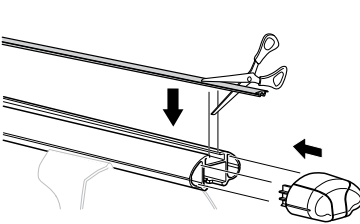
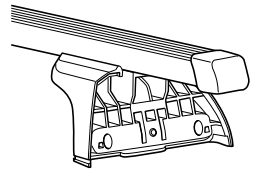
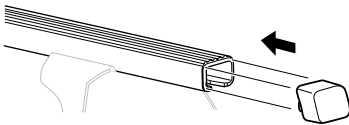
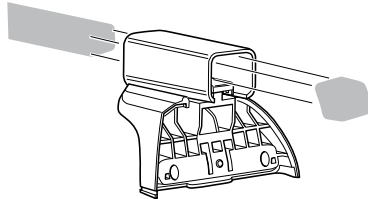
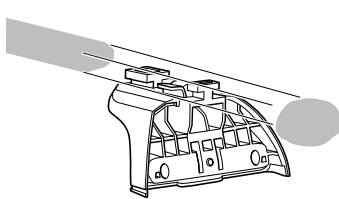

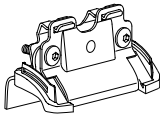
**2****x 4**

<b>i</b>	<b>GB</b> Only a few turns	<b>EST</b> Ainult mõni pööre	<b>HR</b> Samo nekoliko okreta
	<b>D</b> Nur wenige Umdrehungen	<b>LAT</b> Tikai dažī apgriezieni	<b>HU</b> Csak néhány fordítás
	<b>F</b> Quelques tours uniquement	<b>LIT</b> Tik keli pasukimai	<b>GR</b> Μόνο μερικές στροφές
	<b>NL</b> Slechts enkele slagen	<b>PL</b> Wystarczy kilka obrotów	<b>TR</b> Yalnız birkaç kez çevirm
	<b>I</b> Solo qualche giro	<b>RU</b> Достаточно нескольких оборотов	<b>中文</b> 只有几个转向
	<b>E</b> Sólo algunas vueltas	<b>CZ</b> Pouze několik otáček	<b>한국어</b> 두 세번만
	<b>PT</b> Noções básicas	<b>SK</b> Len niekoľko otáčok	<b>日本語</b> 数回転のみ
	<b>S</b> Endast några varv	<b>SLO</b> Le nekaj obratov	<b>ไทย</b> หมุนเพียงไม่กี่รอบ
	<b>FIN</b> Vain muutama kierros		

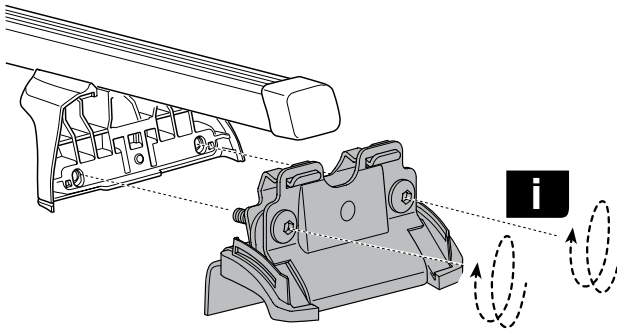
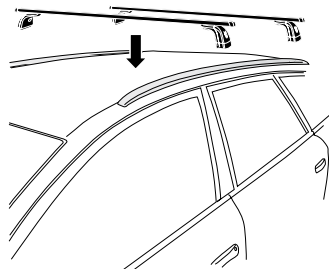
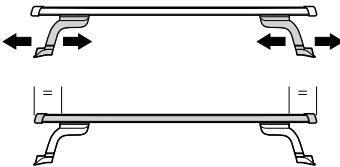
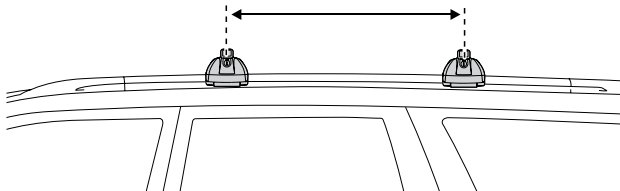
**3****~700 mm**

4

A

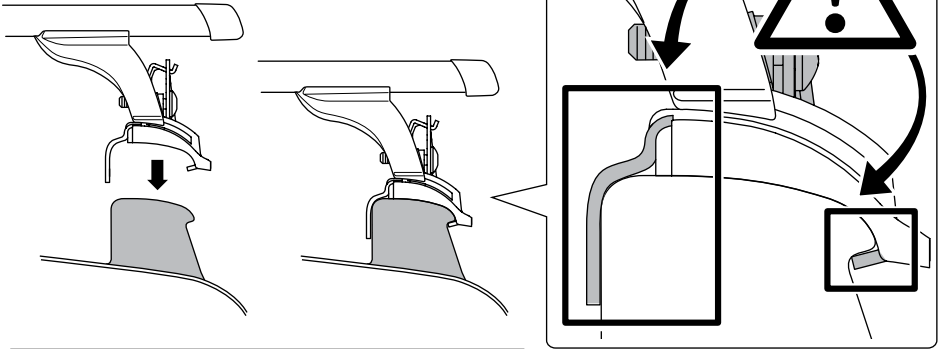

B

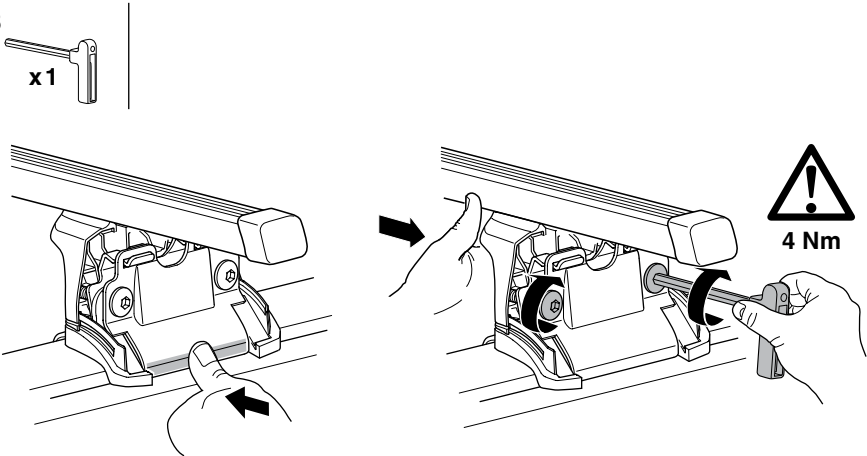

**GB/US** Tighten alternately  
**D** Die Schrauben abwechselnd anziehen  
**F** Serrer alternativement chaque côté  
**NL** Afwisselend aan de linker- en de rechterkant aandraaien  
**I** Alternare il serraggio delle viti  
**E** Apretar alternativamente  
**PT** Aperte alternadamente  
**S** Dra åt växelvis  
**FIN** Kierrä vuorotellen  
**EST** Pinguldage vaheldumisi  
**LAT** Pīvelciēt pamišus  
**LIT** Užsukinėkite pakaitomis  
**PL** Śruby dokręcaj naprzemiennie  
**RU** Затягивайте попеременно

**CZ** Pokrétla багаžníka dokręcaj dokręcaj naprzemiennie.  
**SK** Dotahujte striedavo  
**SLO** Privijajte izmenično.  
**HR** Naizmjenočno zategnite  
**HU** Egymástól függetlenül szorítandó  
**GR** Σφιγγεται εναλλάξ  
**TR** Dönüşümlü sıkın  
**中文** 交替拧紧  
**한국어** 번갈아 가며 조이십시오.  
**日本語** 交互に締め付けてください。  
**ไทย** ซึ้นในแบบสลับ



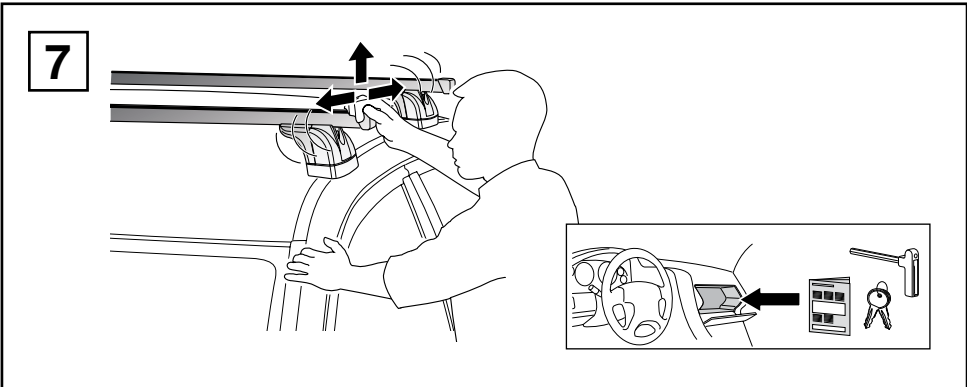
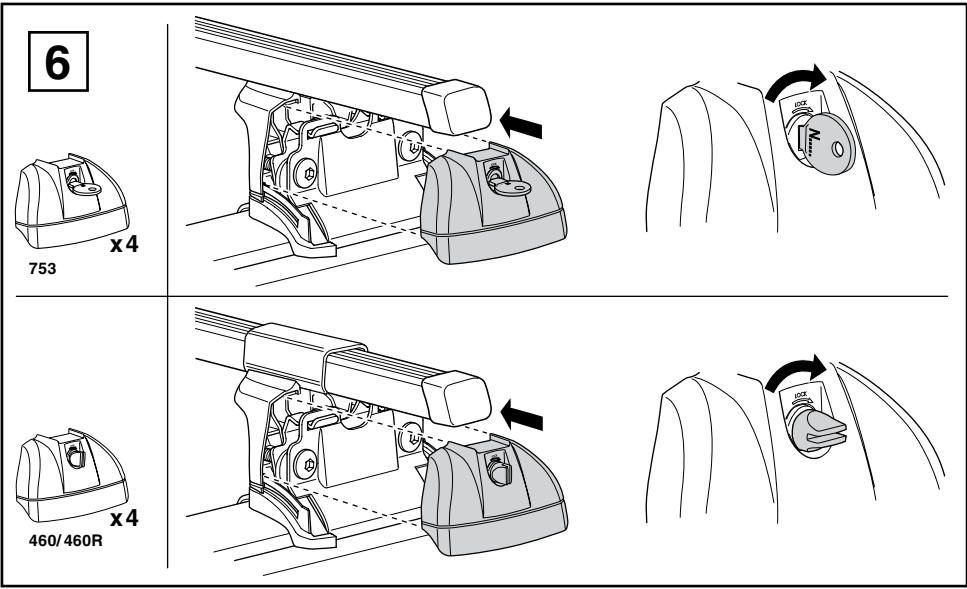
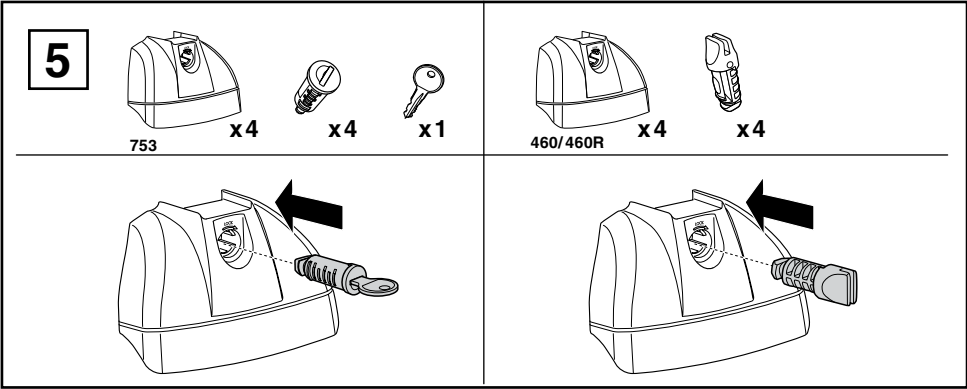

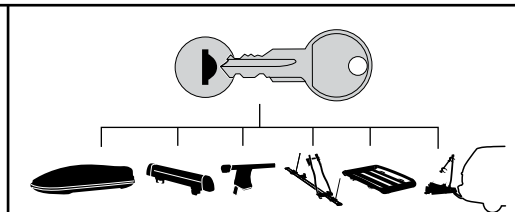
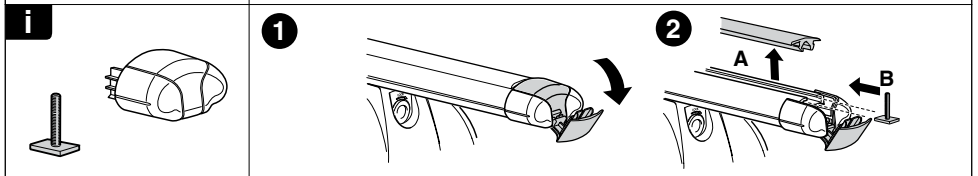
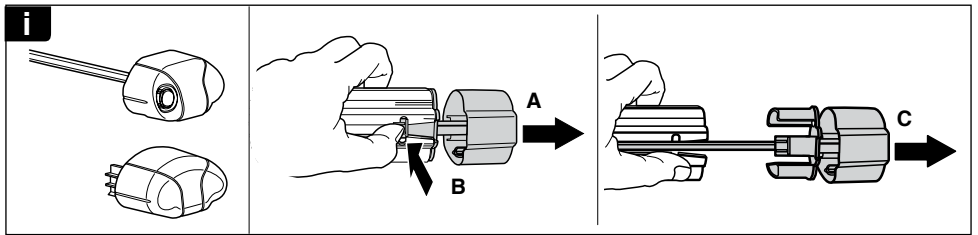
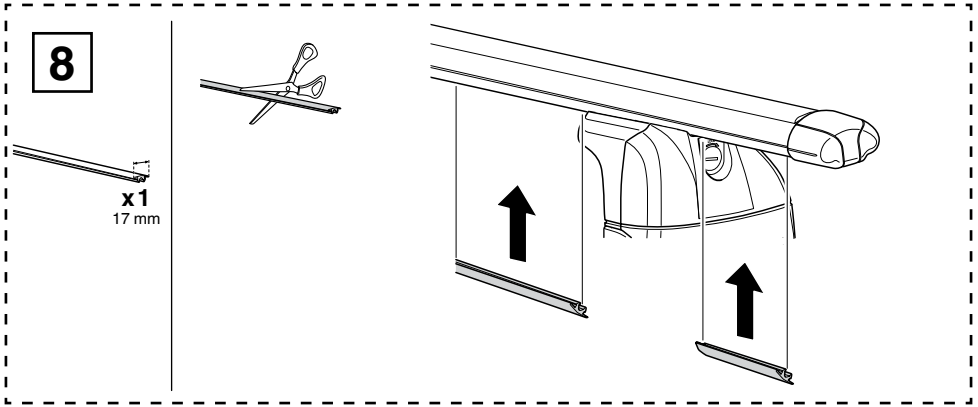

- 544 (x4)
- 596 (x6)
- 588 (x8)
- NA 510 (x10)
- EUR 452 (x12)

WW Thule Sweden AB, Box 69, 330 33 Hillerstorp, SWEDEN  
 NA Thule Inc., 42 Silvermine Road, Seymour, Connecticut 06483, USA

info@thule.com  
 customer.service@thule.com

www.thule.com

506-4030-01