



## Thule Rapid System Kit 4015

# > Instructions

**SEAT Altea XL**, 5-dr MPV, 06-

**SEAT Altea Freetrack**, 5-dr MPV, 07-

**SEAT Ibiza ST**, 5-dr Estate, 10-

**SEAT León ST**, 5-dr Estate, 14-

This kit is only for vehicles with flush or integrated side railing.

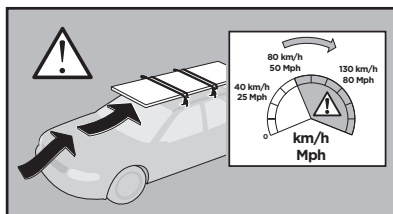
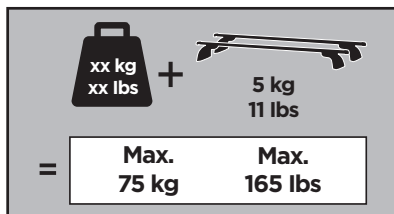
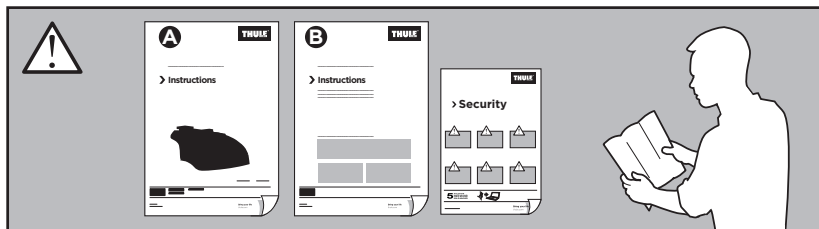

ISO 11154-E

184015

C.20131122  
509-4015-04

Bring your life

thule.com

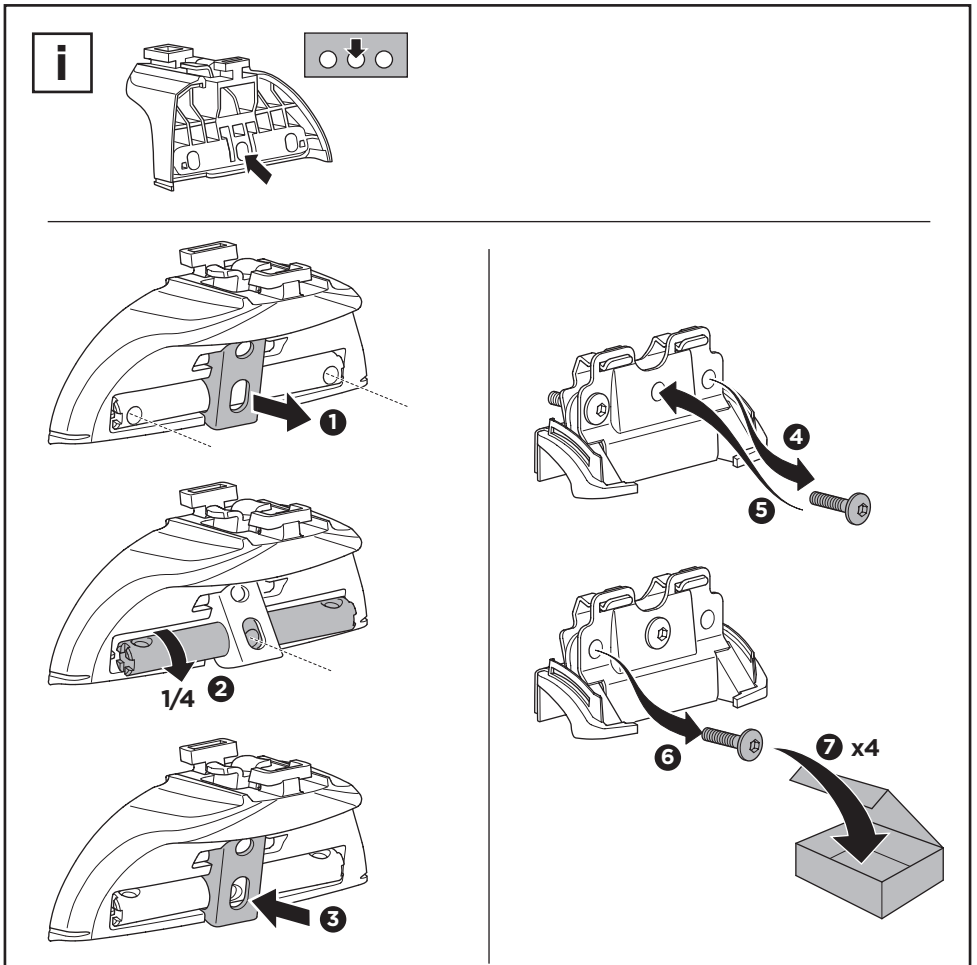
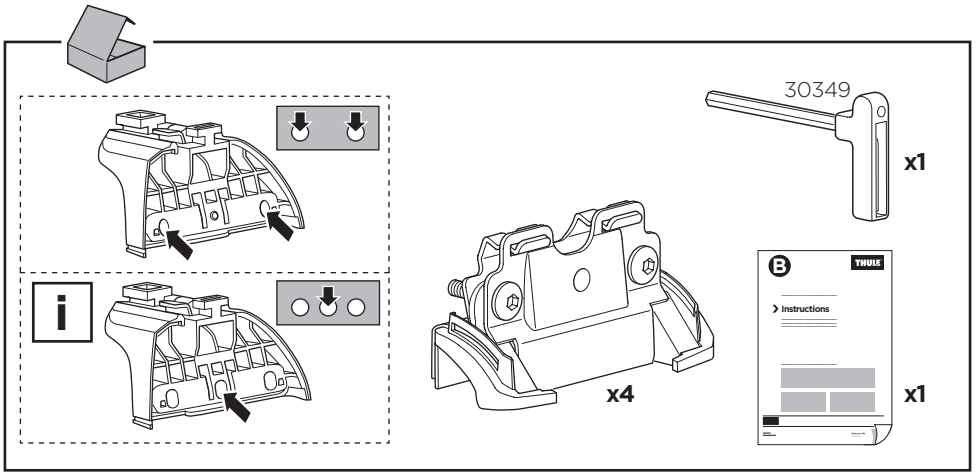

**1**

|                                     |                                     |                                  |
|-------------------------------------|-------------------------------------|----------------------------------|
| <b>EN</b> Only a few turns          | <b>ET</b> Ainult mõni pööre         | <b>RO</b> Doar câteva rotiri     |
| <b>DE</b> Nur wenige Umdrehungen    | <b>LV</b> Tikai daži apgriezieni    | <b>HU</b> Csak néhány fordítás   |
| <b>FR</b> Quelques tours uniquement | <b>LT</b> Tik keli pasukimai        | <b>EL</b> Μόνο λίγες περιστροφές |
| <b>NL</b> Slechts enkele slagen     | <b>PL</b> Wystarczy kilka obrotów   | <b>TR</b> Yalnızca birkaç tur    |
| <b>IT</b> Solo qualche giro         | <b>RU</b> Только несколько оборотов | بعض دورات فقط <b>AR</b>          |
| <b>ES</b> Sólo algunas vueltas      | <b>UK</b> Лише декілька обертів     | רק מספר סיבובים <b>HE</b>        |
| <b>PT</b> Noções básicas            | <b>BG</b> Само няколко завъртания   | <b>ZH</b> 仅几圈                    |
| <b>SV</b> Endast några varv         | <b>CS</b> Pouze několik otáček      | <b>JA</b> 2～3回転のみ                |
| <b>DK</b> Kun nogle få omgange      | <b>SK</b> Len niekoľko otáčok       | <b>KO</b> 몇 번만 돌리면 됨             |
| <b>NE</b> Bare noen få omdreininger | <b>SL</b> Le nekaj obratov          | <b>TH</b> เพียงสองสามรอบ         |
| <b>FI</b> Vain muutama kierros      | <b>HR/BiH</b> Samo nekoliko okreta  |                                  |

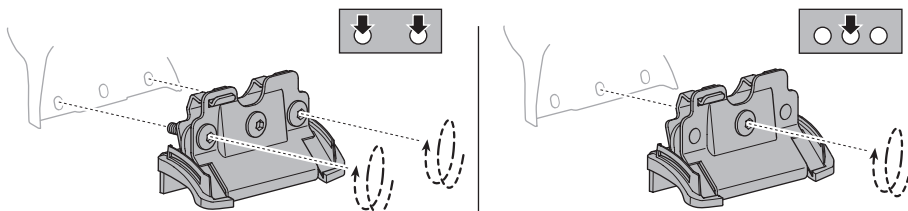
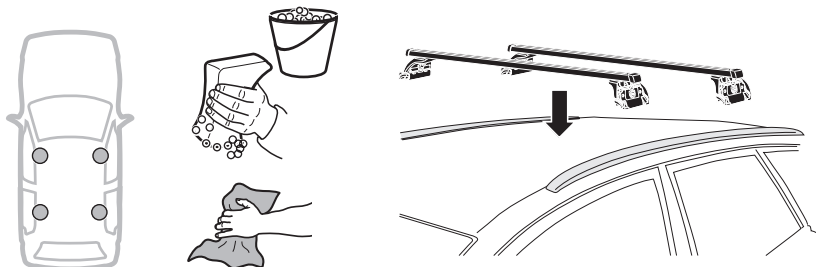
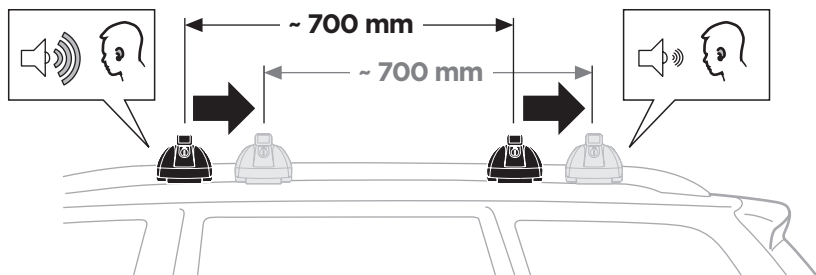
**i****2**

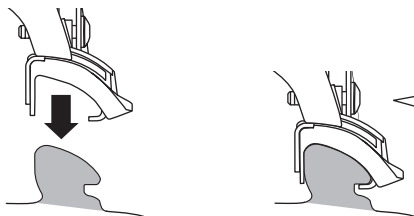
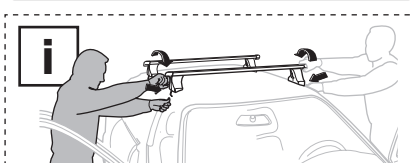
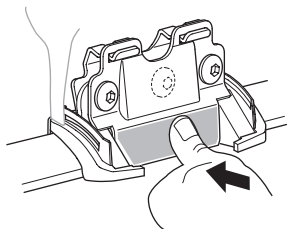
**A****B**

**EN** Tighten alternately  
**DE** Die Schrauben abwechselnd anziehen  
**FR** Serrer alternativement chaque côté  
**NL** Afwisselend aan de linker- en de rechterkant aandraaien

**IT** Alternare il serraggio delle viti

**ES** Apretar alternativamente

**PT** Aperte alternadamente

**SV** Dra åt växelvis

**DK** Spænd skiftevis

**NE** Trekk til vekselvis

**FI** Kierrä vuorotellen

**ET** Pinguldage vaheldumisi

**LV** Pievelciet pamišus

**LT** Užsukinėkite pakaitomis

**PL** Śruby dokręcaj naprzemiennie

**RU** Затягивайте попеременно

**UK** Затягти по чергово

**BG** Затегнете последователно

**CS** Pokręťta bagazníka dokręcaj dokręcaj naprzemiennie.

**SK** Doťahujte striedavo

**SL** Privijajte izmenično

**HR/BiH** Naizmjerno zategnite

**RO** Strângeți alternativ

**HU** Egymástól függetlenül szorítandó

**EL** Ξφίγγείτε εναλλάξ

**TR** Dönüşümlü sıkın

إحكام الربط بالتناوب **AR**

חזק לסימון **HE**

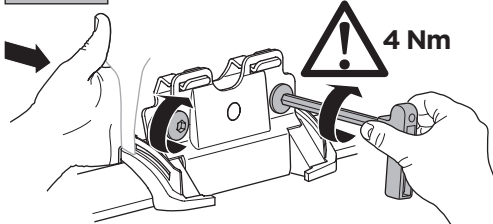
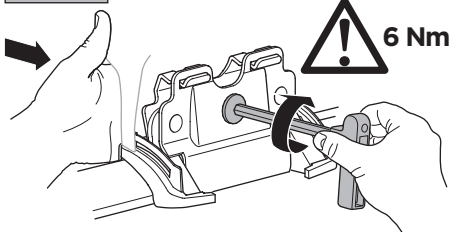
**C****C**

**ZH** 交替拧紧

**JA** 自動固定

**KO** 번갈아 조이기

**TH** ซึ่สลับขัน

