

Kit 3017

- CITROËN C5**, 4-dr Sedan, 08–
- CITROËN C6**, 5-dr Hatchback, 05–
- PEUGEOT 207**, 3-dr Hatchback, 06–
- PEUGEOT 207**, 5-dr Hatchback, 06–
- PEUGEOT 308**, 3-dr Hatchback, 07–
- PEUGEOT 308**, 5-dr Hatchback, 07–
- PEUGEOT 407**, 4-dr Sedan, 04–
- PEUGEOT 3008**, 5-dr SUV, 09–
- PEUGEOT 5008**, 5-dr MPV, 09– (Without glass roof)

This Kit is only for vehicles with fixpoint mounting.



**460R
753**

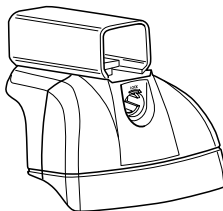

460

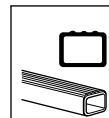

Kit



753



x4



x4



x4



x8

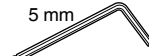

x1



x4



x1

460R

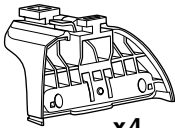

x4



x4



x4



x8

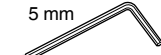

x1



x4

460

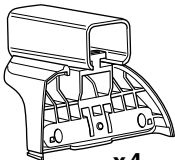

x4



x4



x4



x8

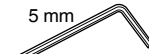

x1



x4

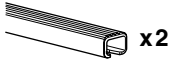

x2



x1

17 mm

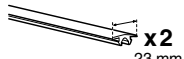

x2

23 mm



x2

23 mm

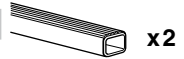

x2

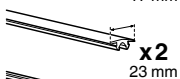

x2

23 mm

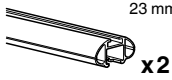

x2



x4

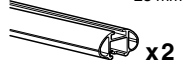

x2



x4



x4

1

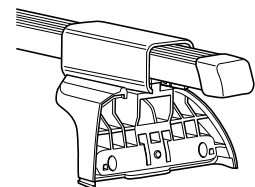
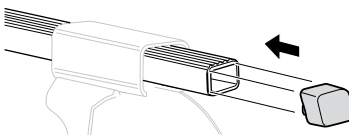
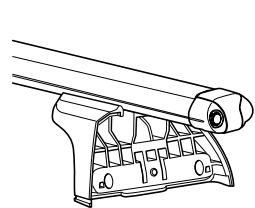
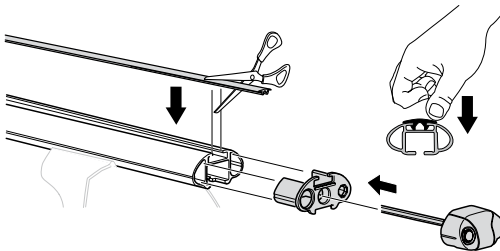
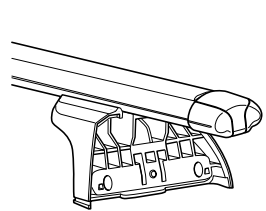
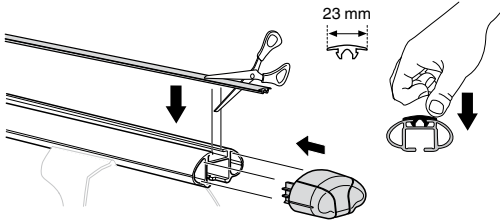
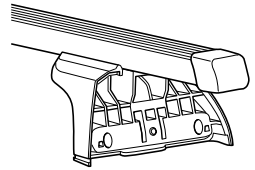
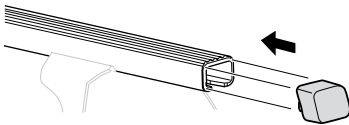
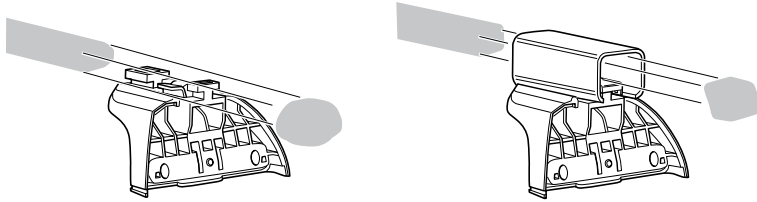
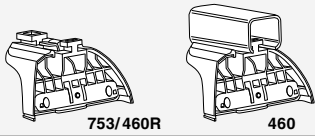

2

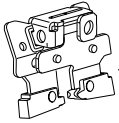

05 / 09 x 2

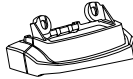

04 x 2

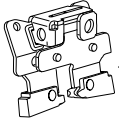

05 / 10 x 2



03 x 2

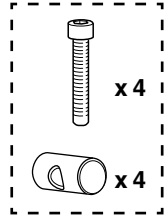

05/10

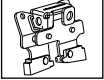

03

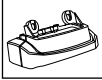

05/09

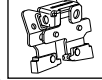

04

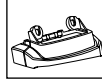

05/09

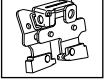

04

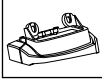

05/10

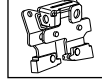

03

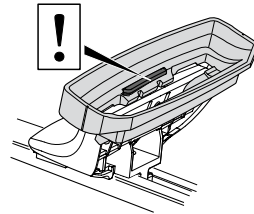
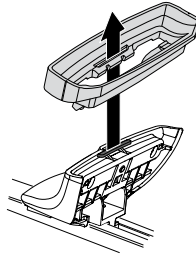
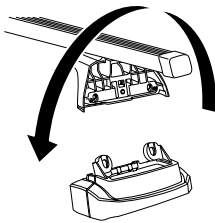

i

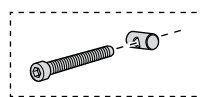
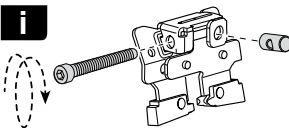

i

- GB** Only a few turns
- D** Nur wenige Umdrehungen
- F** Quelques tours uniquement
- NL** Slechts enkele slagen
- I** Solo qualche giro
- E** Sólo algunas vueltas
- PT** Noções básicas
- S** Endast några varv
- FIN** Vain muutama kierros

- EST** Ainult mõni pööre
- LAT** Tikai dažī apgriezieni
- LIT** Tik keli pasukimai
- PL** Wystarczy kilka obrotów
- RU** Достаточно нескольких оборотов
- CZ** Pouze několik otáček
- SK** Len niekoľko otáčok
- SLO** Le nekaj obratov

- HR** Samo nekoliko okreta
- HU** Csak néhány fordítás
- GR** Μόνο μερικές στροφές
- TR** Yalnız birkaç kez çevirm
- 中文** 只有几个转向
- 한국어** 두 세번만
- 日本語** 数回転のみ
- ไทย** หมุนเพียงไม่กี่รอบ

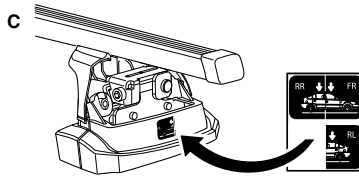
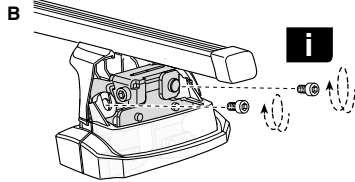
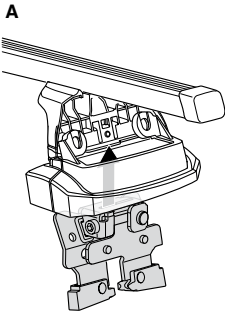
316 mm  x 8**i**

GB Only a few turns
D Nur wenige Umdrehungen
F Quelques tours uniquement
NL Slechts enkele slagen
I Solo qualche giro
E Sólo algunas vueltas
PT Noções básicas
S Endast några varv
FIN Vain muutama kierros
EST Ainult mõni pööre
LAT Tikai dažī apgriezieni
LIT Tik keli pasukimai
PL Wystarczy kilka obrotów
RU Достаточно нескольких оборотов

CZ Pouze několik otáček
SK Len niekoľko otáčok
SLO Le nekaj obratov
HR Samo nekoliko okreta
HU Csak néhány fordítás
GR Μόνο μερικές στροφές
TR Yalnız birkaç kez çevirm
中文 只有几个转向
한국어 두 세번만
日本語 数回転のみ
ไทย หมุนเพียงไม่กี่รอบ

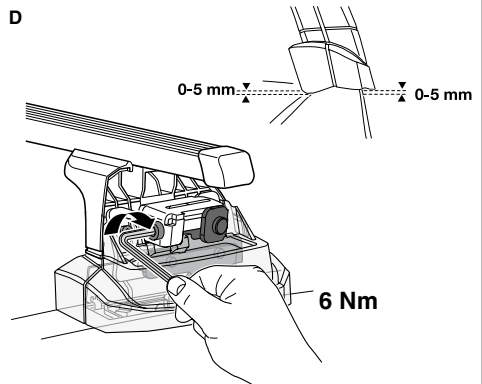
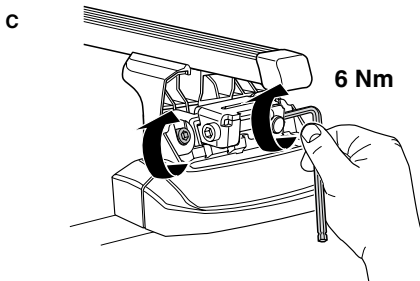
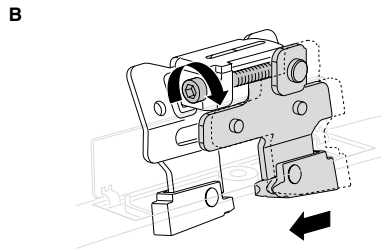
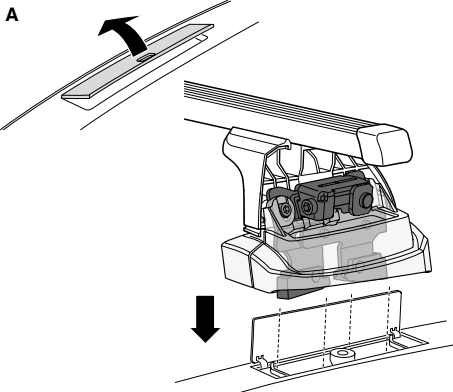
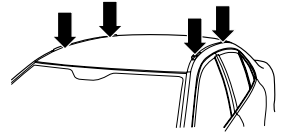
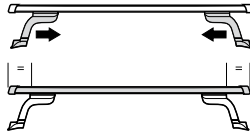
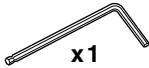
4

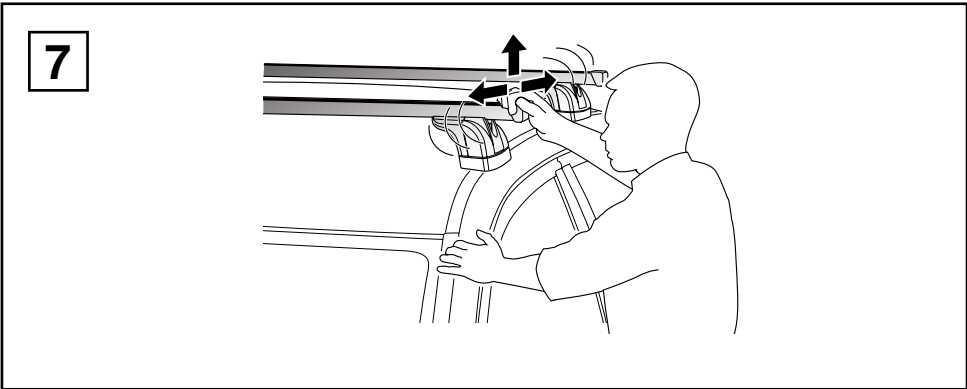
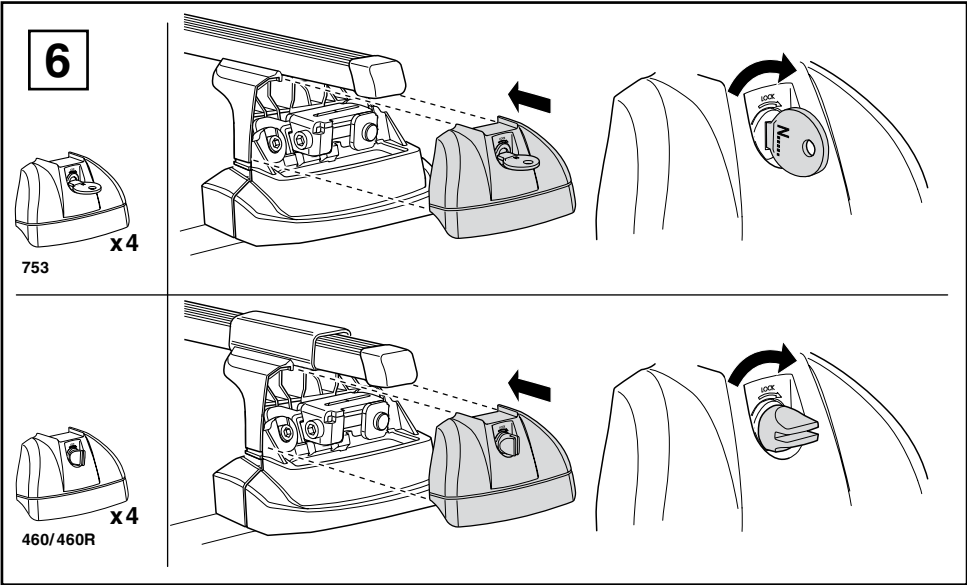
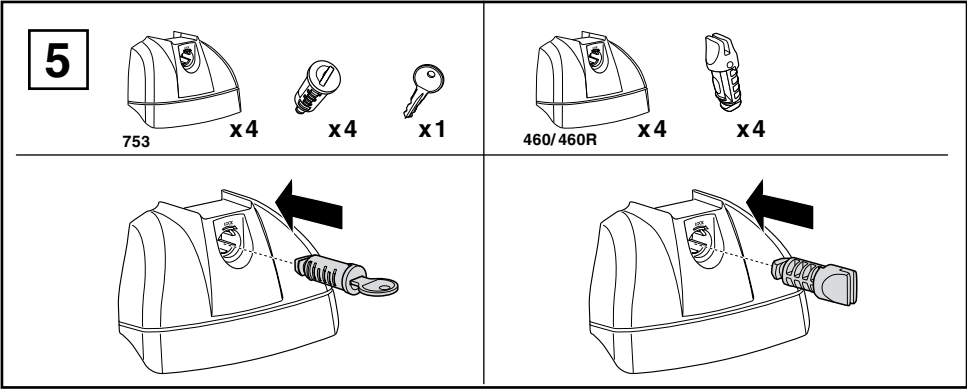

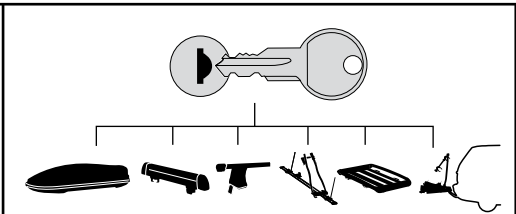
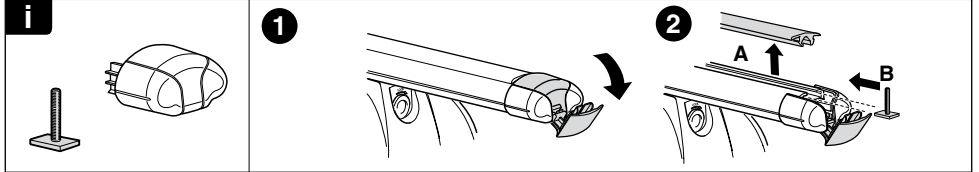
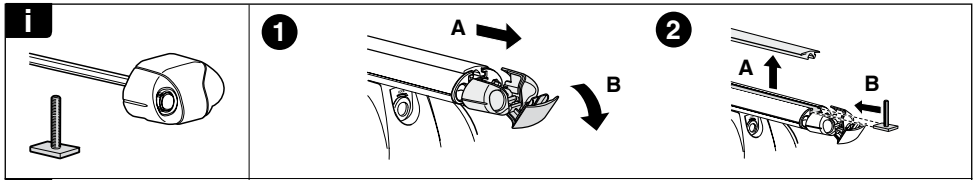
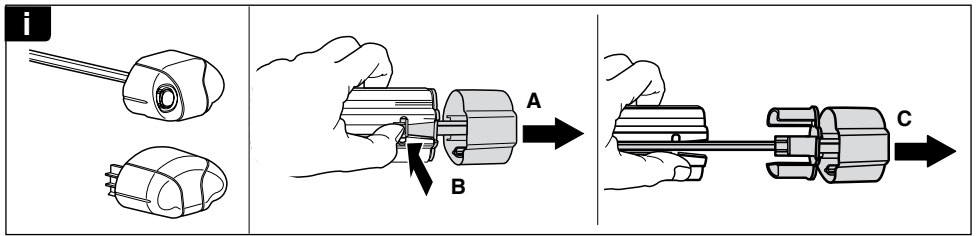
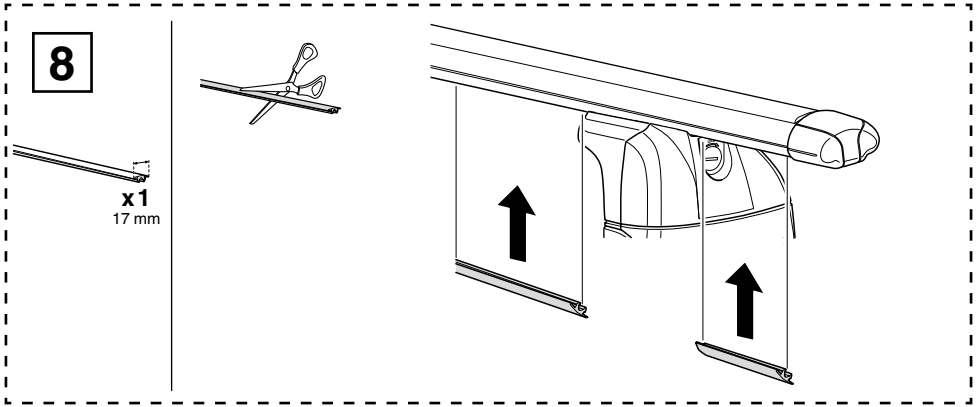

- 544 (x4)
- 596 (x6)
- 588 (x8)
- NA 510 (x10)
- EUR ASIA 452 (x12)

WW ▶ Thule Sweden AB, Box 69, 330 33 Hillerstorp, SWEDEN
 NA ▶ Thule Inc., 42 Silvermine Road, Seymour, Connecticut 06483, USA

info@thule.com
 customer.service@thule.com

www.thule.com