

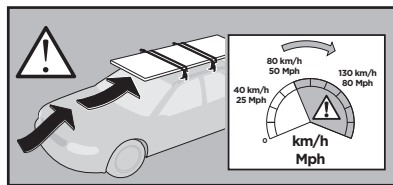

Thule Rapid System Kit 1863

> Instructions

VOLKSWAGEN Arteon, 5-dr Hatchback, 17-

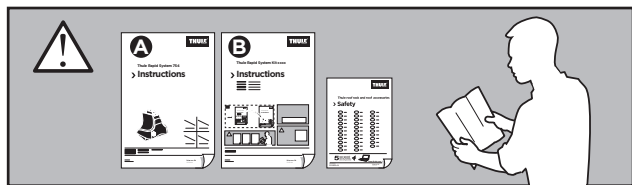
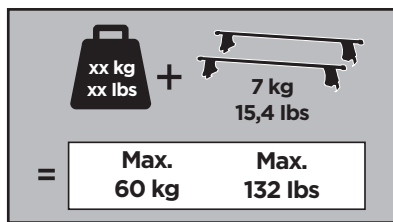
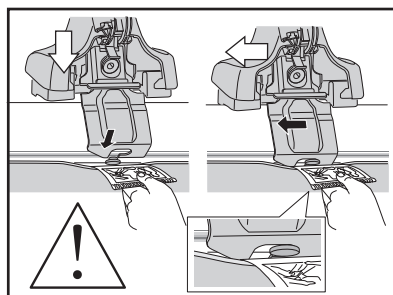
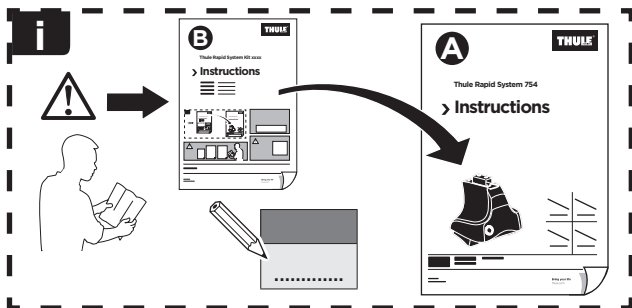
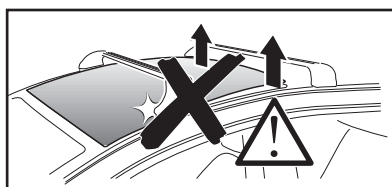

ISO 11154-E

141863

C.20180630
519-1863-02

Bring your life
thule.com



78 x1 ▶

79 x1 ▶

165 x1 ▶

166 x1 ▶

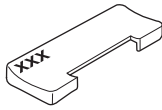

◀ 1424 x2

◀ 1425 x2



x1

52576



x2

50993

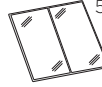

x2



x1

1

	X (scale)	X (mm)	X (inch)
VOLKSWAGEN Arteon, 5-dr Hatchback, 17-	46,5	1116	43 ⁷/₈

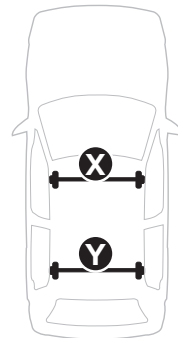
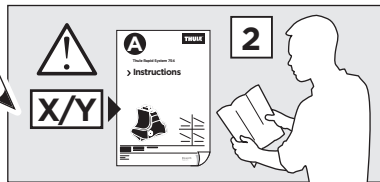
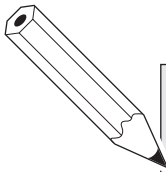

	Y (scale)	Y (mm)	Y (inch)
VOLKSWAGEN Arteon, 5-dr Hatchback, 17-	41,5	1066	42

2

VOLKSWAGEN Arteon, 5-dr Hatchback, 17-

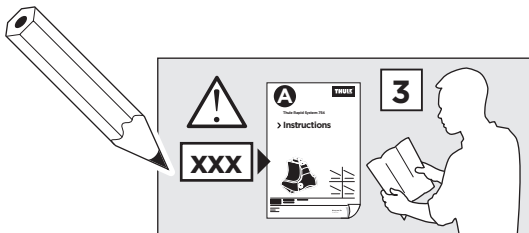
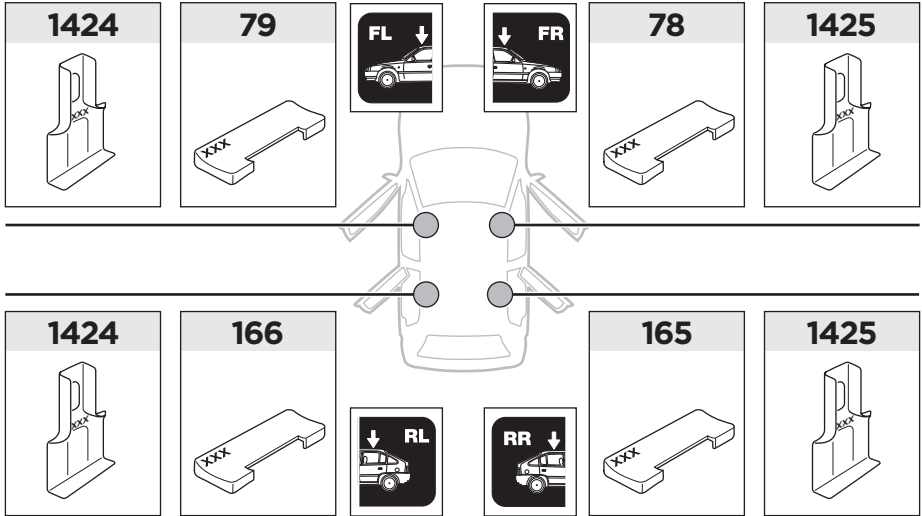

3

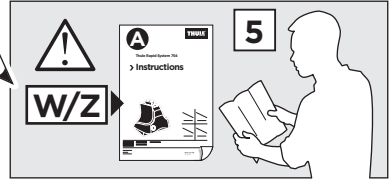

	W (mm)	Z (mm)	W (inch)	Z (inch)
VOLKSWAGEN Arteon, 5-dr Hatchback, 17-	145	760	5 ³/₄	29 ⁷/₈

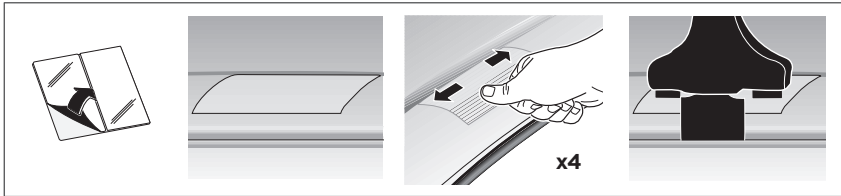
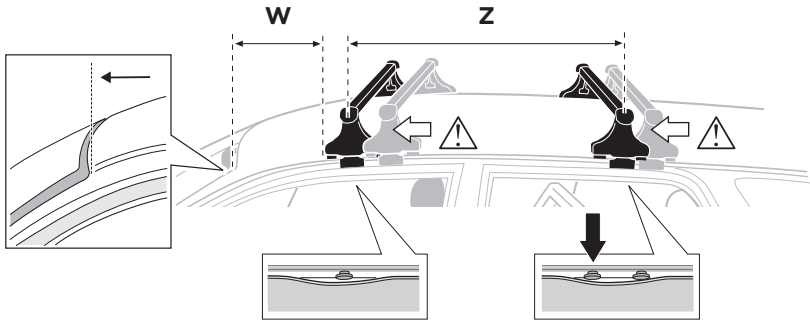

x2

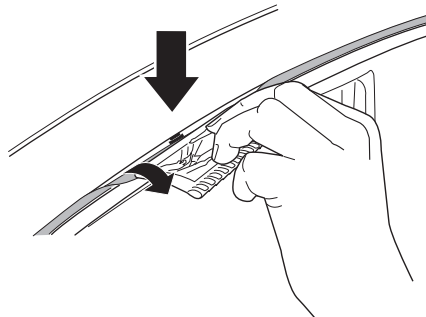

4

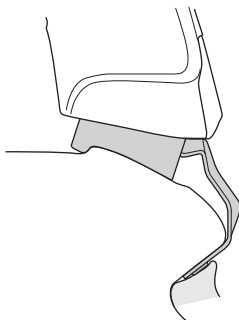
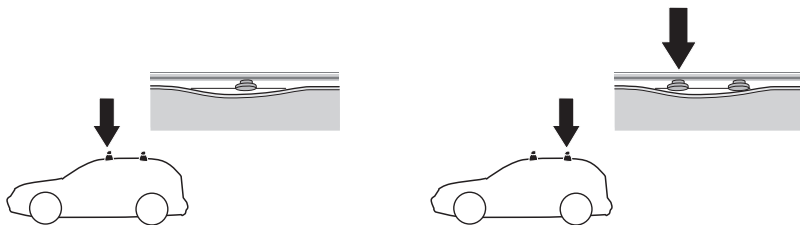
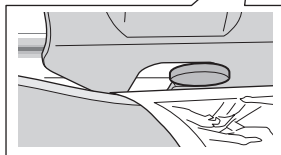
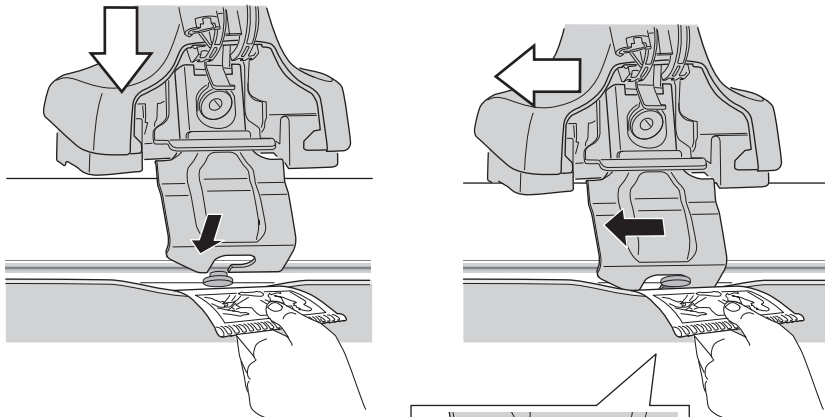



Thule Sweden AB, Borggatan 5, 335 73 Hillerstorp, SWEDEN
Thule Inc., 42 Silvermine Road, Seymour, Connecticut 06483, USA



info@thule.com
Phone: 800-238-2388



www.thule.com