

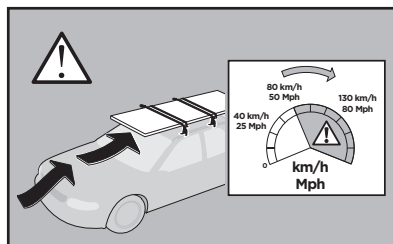

# Thule Rapid System Kit 1803

## > Instructions

TOYOTA Highlander, 5-dr SUV, 14-  
TOYOTA Kluger, 5-dr SUV, 14-

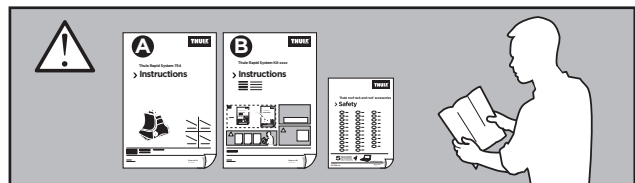
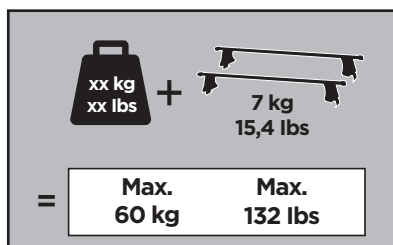

ISO 11154-E

141803  
C.20160504  
519-1803-01

Bring your life  
thule.com



204 x1

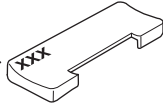

206 x1

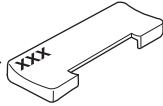

328 x2

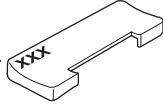

544 x2



519 x2



x1



x1

1

	X (scale)	X (mm)	X (inch)
<b>TOYOTA Highlander</b> , 5-dr SUV, 14-	50	1151	45 <sup>3</sup> / <sub>8</sub>
<b>TOYOTA Kluger</b> , 5-dr SUV, 14-	50	1151	45 <sup>3</sup> / <sub>8</sub>

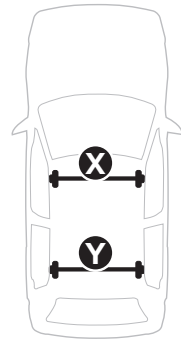
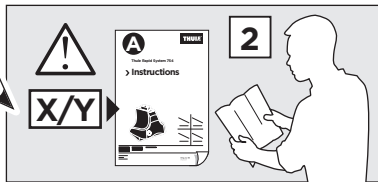
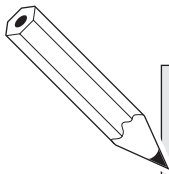

	Y (scale)	Y (mm)	Y (inch)
<b>TOYOTA Highlander</b> , 5-dr SUV, 14-	47	1121	44 <sup>1</sup> / <sub>8</sub>
<b>TOYOTA Kluger</b> , 5-dr SUV, 14-	47	1121	44 <sup>1</sup> / <sub>8</sub>

**2**

**TOYOTA Highlander**, 5-dr SUV, 14-

**TOYOTA Kluger**, 5-dr SUV, 14-

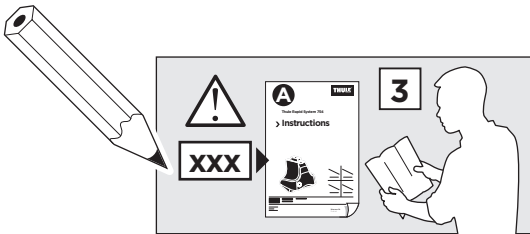
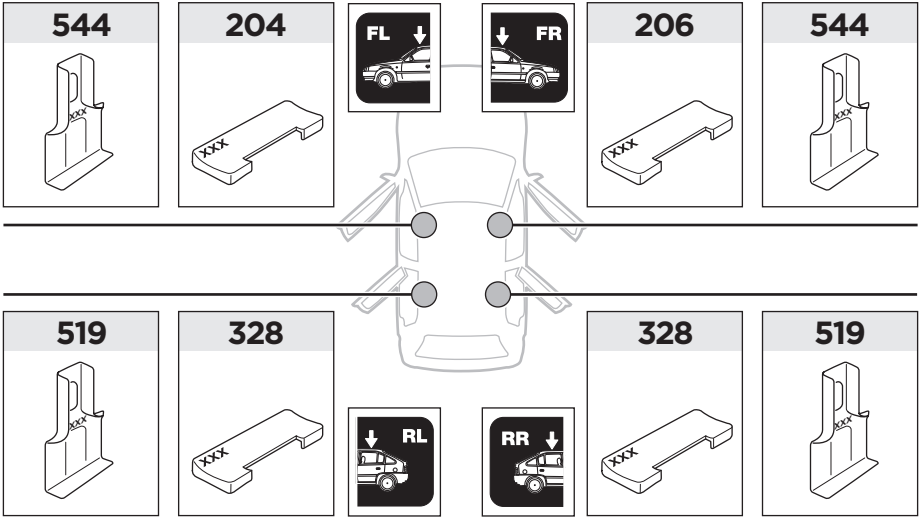

3

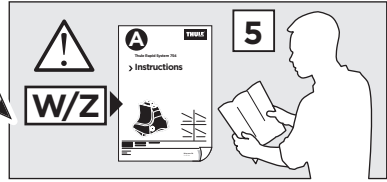

	W (mm)	Z (mm)	W (inch)	Z (inch)
<b>TOYOTA Highlander</b> , 5-dr SUV, 14-	335	750	13 1/4	29 1/2
<b>TOYOTA Kluger</b> , 5-dr SUV, 14-	335	750	13 1/4	29 1/2

