

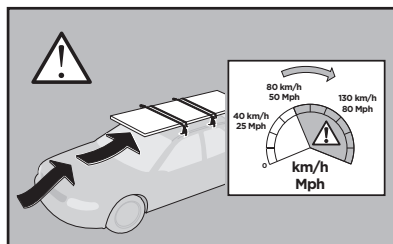

## Thule Rapid System Kit 1783

# > Instructions

**CHEVROLET Colorado**, 4-dr Crew Cab, 15-  
**CHEVROLET S10**, 4-dr Double Cab, 12-  
**GMC Canyon**, 4-dr Crew Cab, 15-  
**HOLDEN Colorado**, 4-dr Double Cab, 12-  
**ISUZU D-Max**, 4-dr Crew Cab, 12-

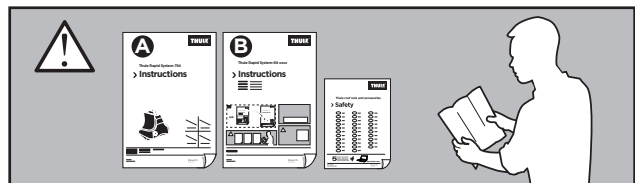
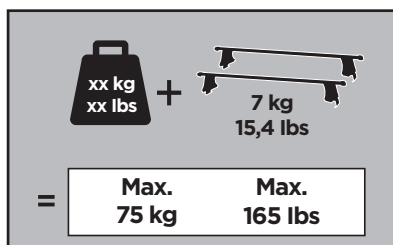
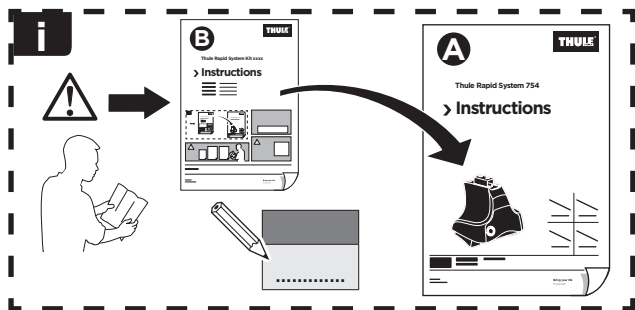

ISO 11154-E

141783  
C.20150310  
519-1783-01

Bring your life  
thule.com



390 x2

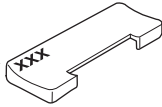

391 x1

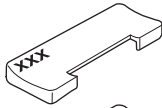

392 x1

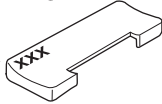

1234 x4

52597

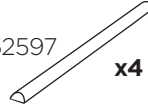

x4



x1



x1

1

	X (scale)	X (mm)	X (inch)
<b>CHEVROLET Colorado</b> , 4-dr Crew Cab, 15-	38	1031	40 <sup>5</sup> / <sub>8</sub>
<b>CHEVROLET S10</b> , 4-dr Double Cab, 12-	38	1031	40 <sup>5</sup> / <sub>8</sub>
<b>GMC Canyon</b> , 4-dr Crew Cab, 15-	38	1031	40 <sup>5</sup> / <sub>8</sub>
<b>HOLDEN Colorado</b> , 4-dr Double Cab, 12-	38	1031	40 <sup>5</sup> / <sub>8</sub>
<b>ISUZU D-Max</b> , 4-dr Crew Cab, 12-	38	1031	40 <sup>5</sup> / <sub>8</sub>

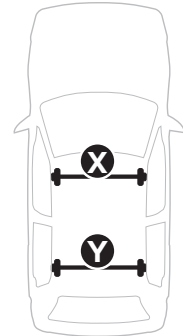
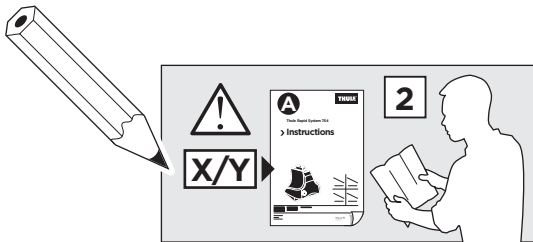

	Y (scale)	Y (mm)	Y (inch)
<b>CHEVROLET Colorado</b> , 4-dr Crew Cab, 15-	35.5	1006	39 <sup>5</sup> / <sub>8</sub>
<b>CHEVROLET S10</b> , 4-dr Double Cab, 12-	35.5	1006	39 <sup>5</sup> / <sub>8</sub>
<b>GMC Canyon</b> , 4-dr Crew Cab, 15-	35.5	1006	39 <sup>5</sup> / <sub>8</sub>
<b>HOLDEN Colorado</b> , 4-dr Double Cab, 12-	35.5	1006	39 <sup>5</sup> / <sub>8</sub>
<b>ISUZU D-Max</b> , 4-dr Crew Cab, 12-	35.5	1006	39 <sup>5</sup> / <sub>8</sub>

2

**CHEVROLET Colorado**, 4-dr Crew Cab, 15-  
**CHEVROLET S10**, 4-dr Double Cab, 12-  
**GMC Canyon**, 4-dr Crew Cab, 15-  
**HOLDEN Colorado**, 4-dr Double Cab, 12-  
**ISUZU D-Max**, 4-dr Crew Cab, 12-

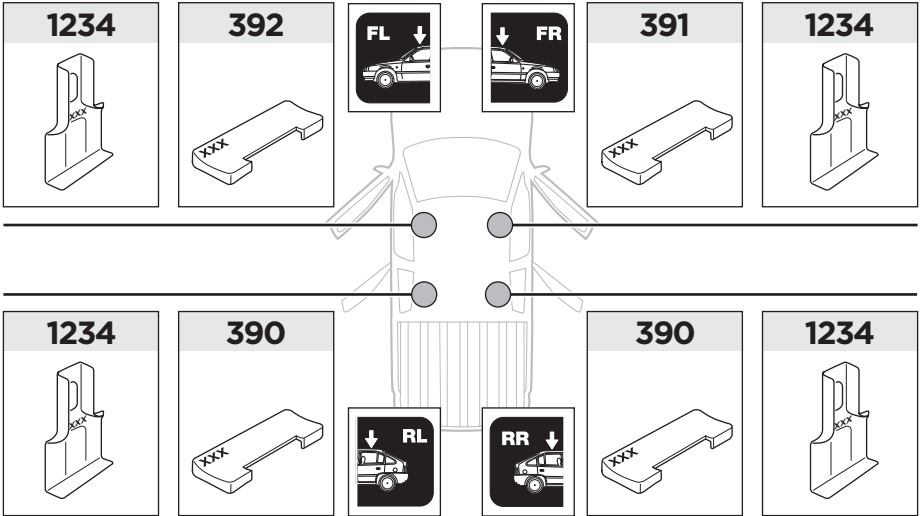

3

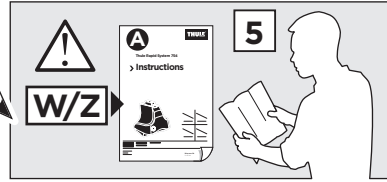

	W (mm)	Z (mm)	W (inch)	Z (inch)
<b>CHEVROLET Colorado</b> , 4-dr Crew Cab, 15-	250	700	9 7/8	27 1/4
<b>CHEVROLET S10</b> , 4-dr Double Cab, 12-	250	700	9 7/8	27 1/4
<b>GMC Canyon</b> , 4-dr Crew Cab, 15-	250	700	9 7/8	27 1/4
<b>HOLDEN Colorado</b> , 4-dr Double Cab, 12-	250	700	9 7/8	27 1/4
<b>ISUZU D-Max</b> , 4-dr Crew Cab, 12-	250	700	9 7/8	27 1/4

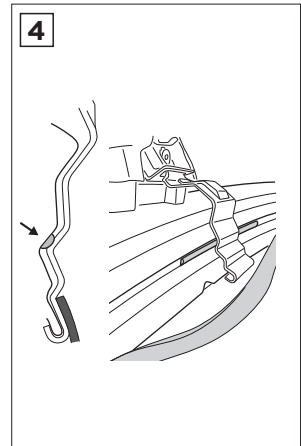
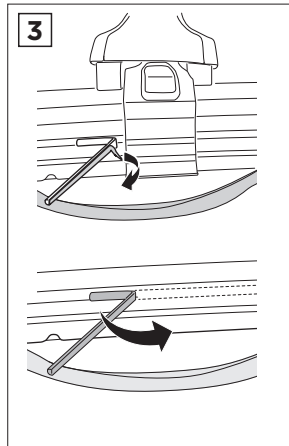
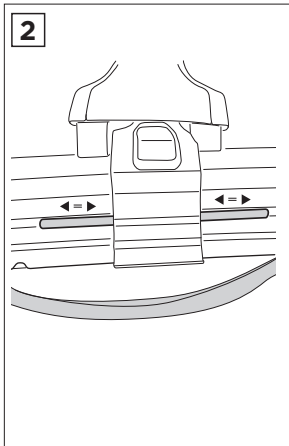
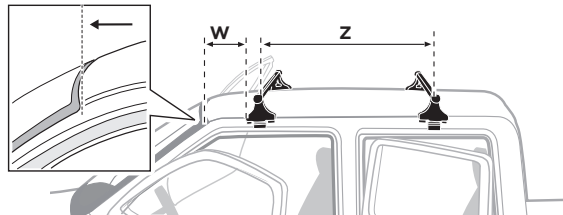
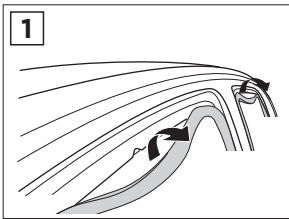

4

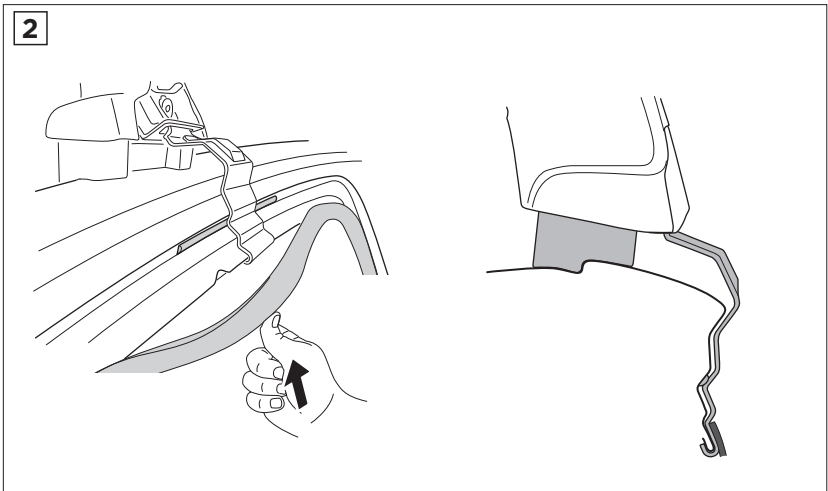
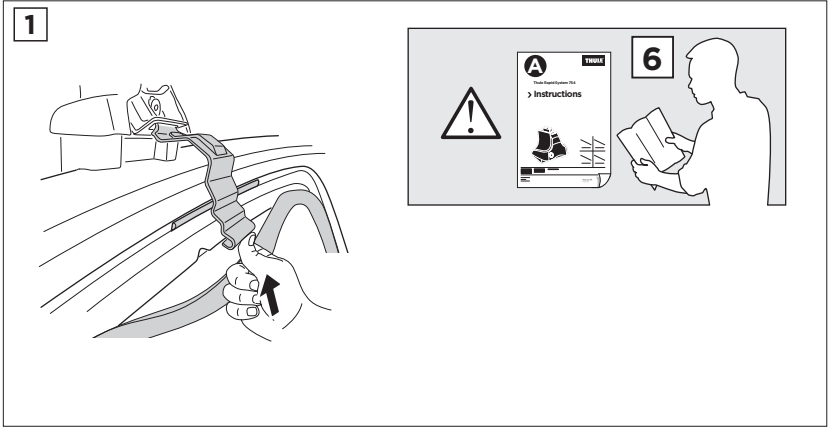

Thule Sweden AB, Box 69, 330 33 Hillerstorp, SWEDEN  
Thule Inc., 42 Silvermine Road, Seymour, Connecticut 06483, USA

info@thule.com  
Phone: 800-238-2388

 www.thule.com

» PART OF THULE GROUP

© Thule Group 2015. All rights reserved.





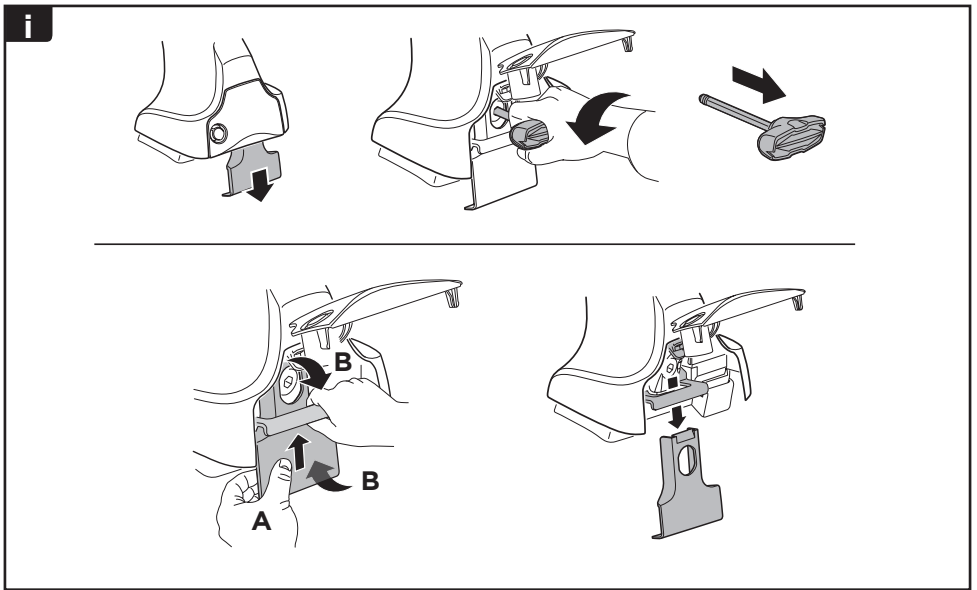
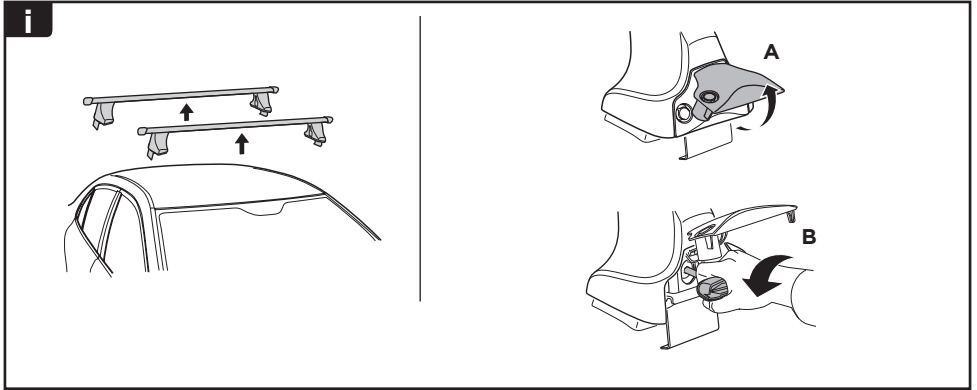

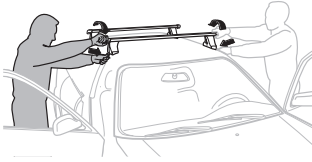

**8**

**EN** Tighten alternately  
**DE** Die Schrauben abwechselnd anziehen  
**FR** Serrer alternativement chaque côté  
**NL** Afwisselend aan de linker- en de rechterkant aandraaien  
**IT** Alternare il serraggio delle viti  
**ES** Apretar alternativamente  
**PT** Aperte alternadamente  
**SV** Dra åt växelvis  
**DK** Spænd skiftevis  
**NO** Trekk til vekselvis  
**FI** Kierrä vuorotellen  
**ET** Pinguldage vaheldumisi  
**LV** Pīvelciēt pamīšus  
**LT** Užsukinėkite pakaitomis  
**PL** Śruby dokręcaj naprzemiennie  
**RU** Затягивайте попеременно

**UK** Затягти почергово  
**BG** Затегнете последователно  
**CS** Pokreťta багаžníka dokręcaj dokręcaj naprzemiennie.  
**SK** Dofahujtie striedavo  
**SL** Privijajte izmenično  
**HR/BIH** Naizmjenično zategnite  
**RO** Strângeți alternativ  
**HU** Egy mástól függetlenül szorítandó  
**EL** Σφιγγετε εναλλάξ  
**TR** Dönüşümlü sıkın  
**AR** إسكاف الربط بالتناوب  
**HE** סרקן לסירוגין  
**ZH** 交替拧紧  
**JA** 左右交互に締めつけてください  
**KO** 번갈아 조이기  
**TH** ขั้วในแบบสลับ

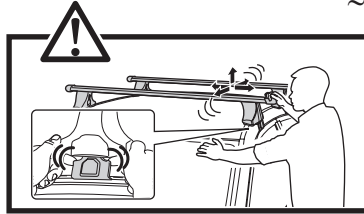
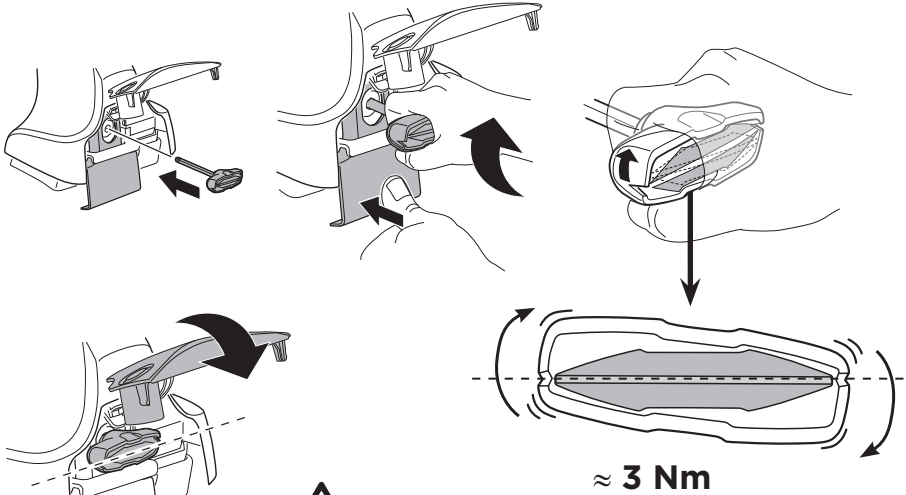
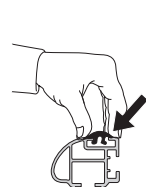
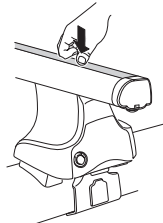
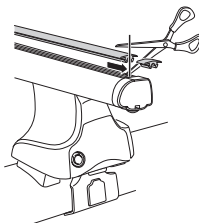
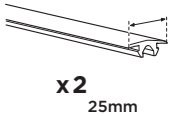
**9**

# 7

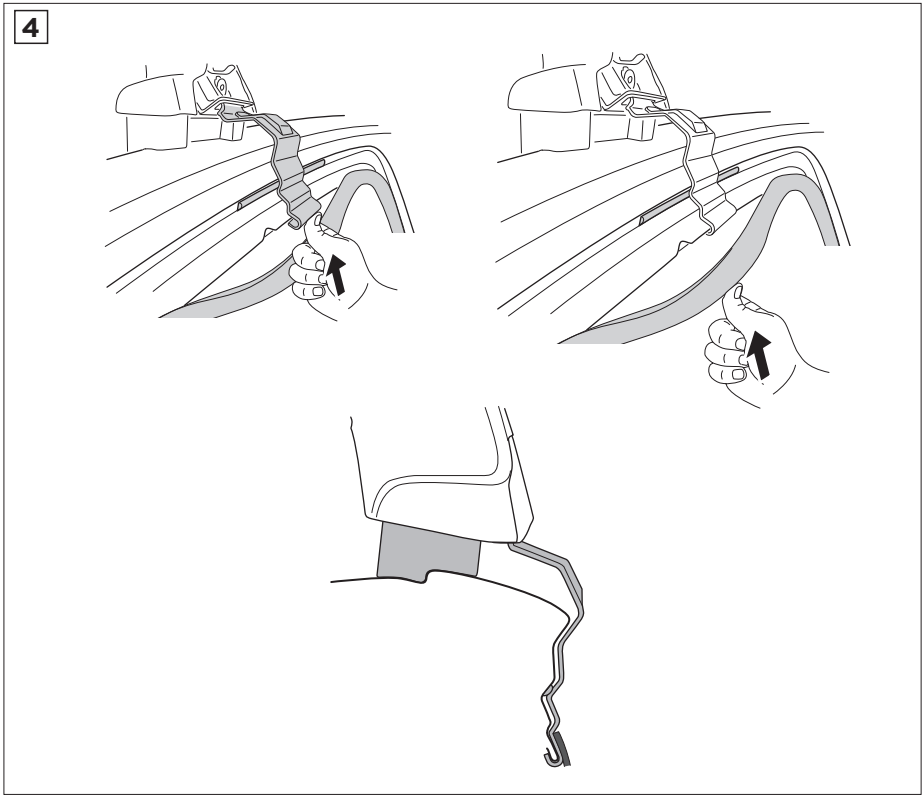
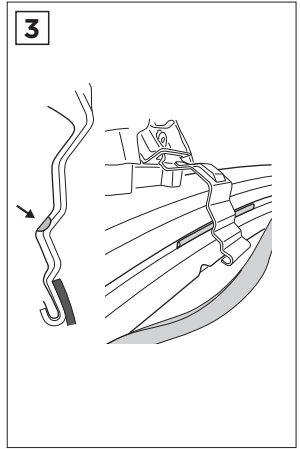
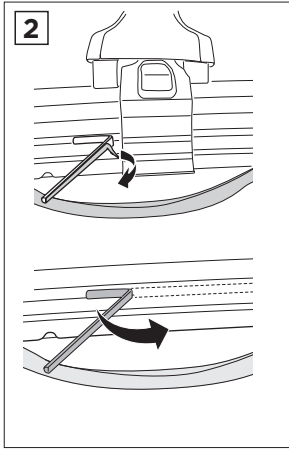
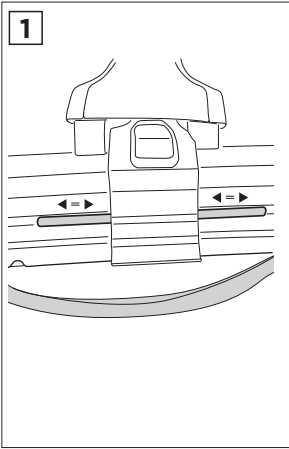

6

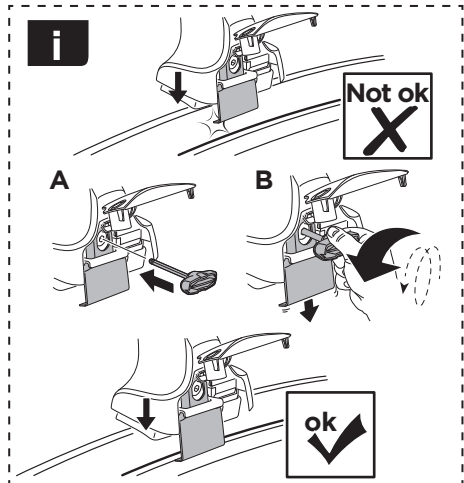
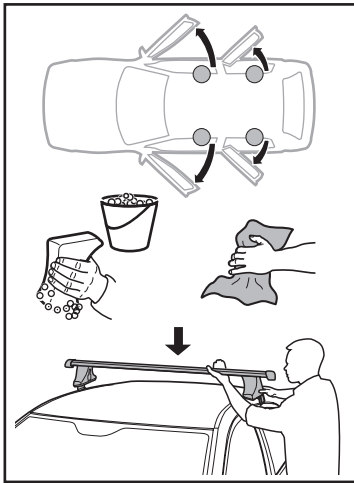

	X mm	Y mm	X inch	Y inch
<b>CHEVROLET Colorado</b> , 4-dr Crew Cab, 15-	250 mm	700 mm	9 <sup>7</sup> / <sub>8</sub> ''	27 <sup>1</sup> / <sub>2</sub> ''
<b>CHEVROLET S10</b> , 4-dr Double Cab, 12-	250 mm	700 mm	9 <sup>7</sup> / <sub>8</sub> ''	27 <sup>1</sup> / <sub>2</sub> ''
<b>GMC Canyon</b> , 4-dr Crew Cab, 15-	250 mm	700 mm	9 <sup>7</sup> / <sub>8</sub> ''	27 <sup>1</sup> / <sub>2</sub> ''
<b>HOLDEN Colorado</b> , 4-dr Double Cab, 12-	250 mm	700 mm	9 <sup>7</sup> / <sub>8</sub> ''	27 <sup>1</sup> / <sub>2</sub> ''
<b>ISUZU D-Max</b> , 4-dr Crew Cab, 12-	250 mm	700 mm	9 <sup>7</sup> / <sub>8</sub> ''	27 <sup>1</sup> / <sub>2</sub> ''

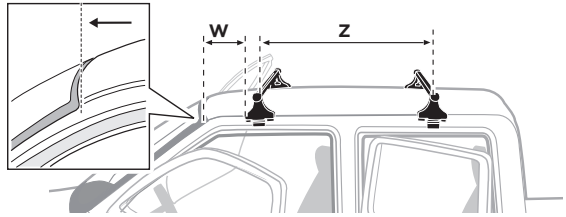
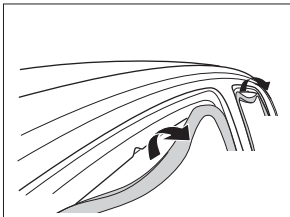

**5**

**CHEVROLET Colorado**, 4-dr Crew Cab, 15-

**CHEVROLET S10**, 4-dr Double Cab, 12-

**GMC Canyon**, 4-dr Crew Cab, 15-

**HOLDEN Colorado**, 4-dr Double Cab, 12-

**ISUZU D-Max**, 4-dr Crew Cab, 12-

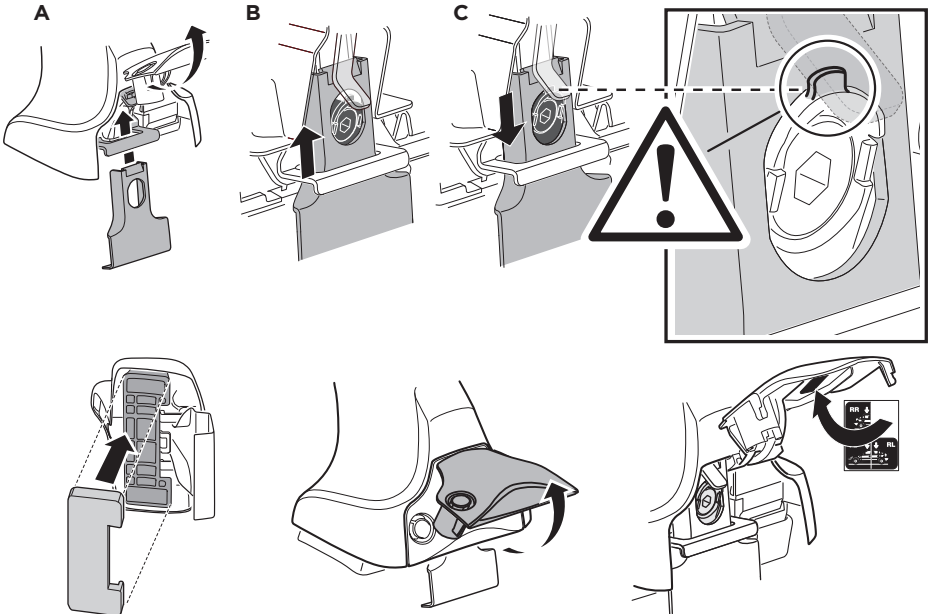
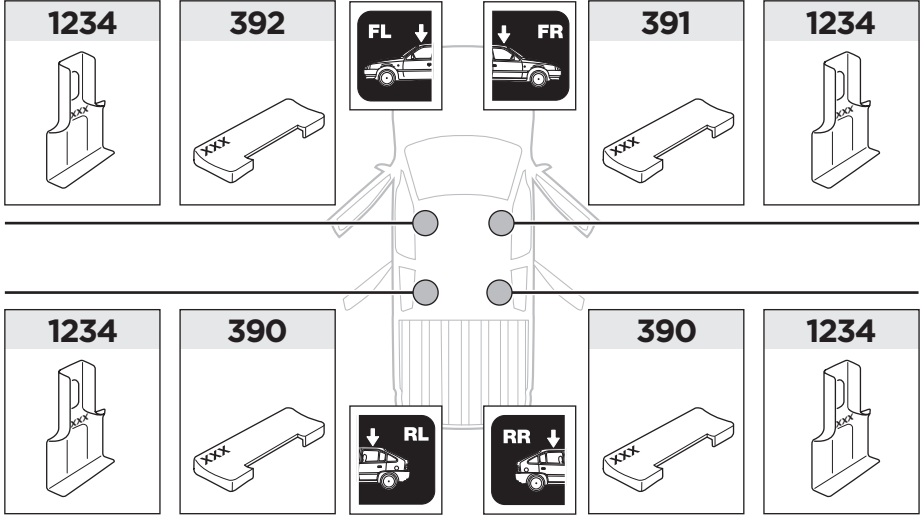

**3**

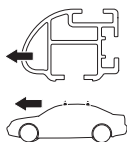

**1**

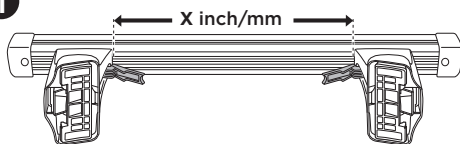

**2**

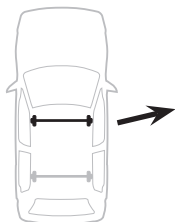
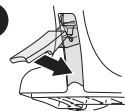

**X inch    X mm**

<b>CHEVROLET Colorado, 4-dr Crew Cab, 15-</b>	<b>38</b>	<b>1031</b>
<b>CHEVROLET S10, 4-dr Double Cab, 12-</b>	<b>38</b>	<b>1031</b>
<b>GMC Canyon, 4-dr Crew Cab, 15-</b>	<b>38</b>	<b>1031</b>
<b>HOLDEN Colorado, 4-dr Double Cab, 12-</b>	<b>38</b>	<b>1031</b>
<b>ISUZU D-Max, 4-dr Crew Cab, 12-</b>	<b>38</b>	<b>1031</b>

**1**

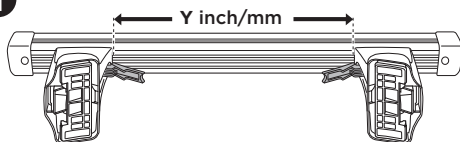

**2**

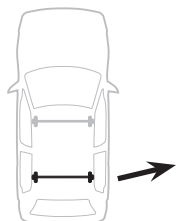
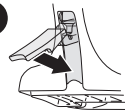

**Y inch    Y mm**

<b>CHEVROLET Colorado, 4-dr Crew Cab, 15-</b>	<b>35,5</b>	<b>1006</b>
<b>CHEVROLET S10, 4-dr Double Cab, 12-</b>	<b>35,5</b>	<b>1006</b>
<b>GMC Canyon, 4-dr Crew Cab, 15-</b>	<b>35,5</b>	<b>1006</b>
<b>HOLDEN Colorado, 4-dr Double Cab, 12-</b>	<b>35,5</b>	<b>1006</b>
<b>ISUZU D-Max, 4-dr Crew Cab, 12-</b>	<b>35,5</b>	<b>1006</b>

**4**

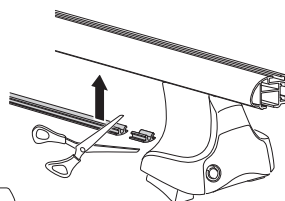
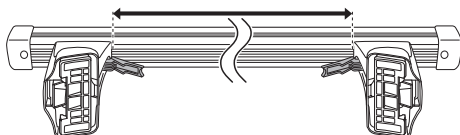

1

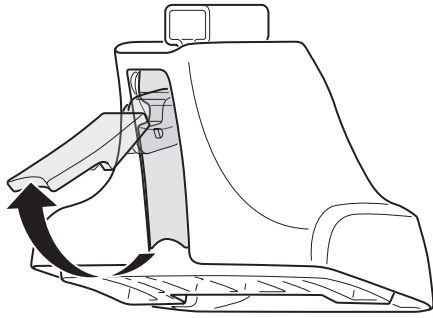

2



x2



x2



x4



x4



x1 5mm

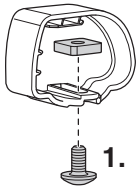
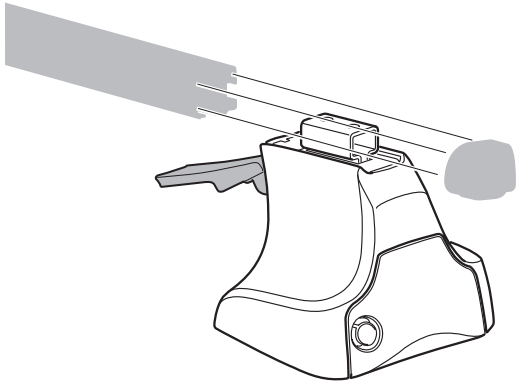
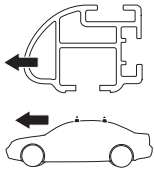

1.

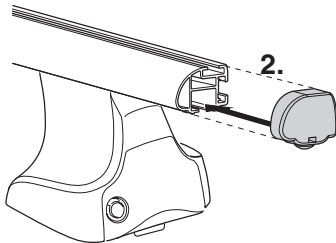

2.

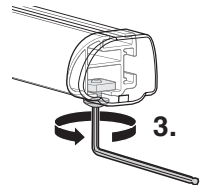

3.

480R / 754

# instructions

# Kit 1783

**CHEVROLET Colorado**, 4-dr Crew Cab, 15-  
**CHEVROLET S10**, 4-dr Double Cab, 12-  
**GMC Canyon**, 4-dr Crew Cab, 15-  
**HOLDEN Colorado**, 4-dr Double Cab, 12-  
**ISUZU D-Max**, 4-dr Crew Cab, 12-

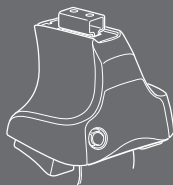

480R  
754

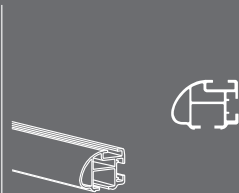

**THULE**<sup>®</sup>  
SWEDEN  
**PROFESSIONAL**

ISO 11154-E