



Thule XT Kit 3143

> Instructions

OPEL Corsa E, 3-dr Hatchback, 15-

OPEL Corsa E, 5-dr Hatchback, 15-

This kit is only for vehicles with fixpoint mounting.

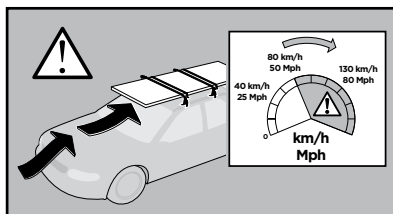
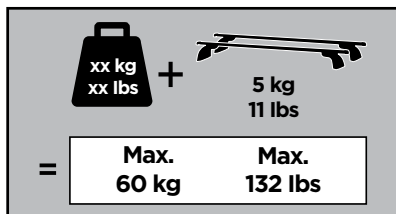
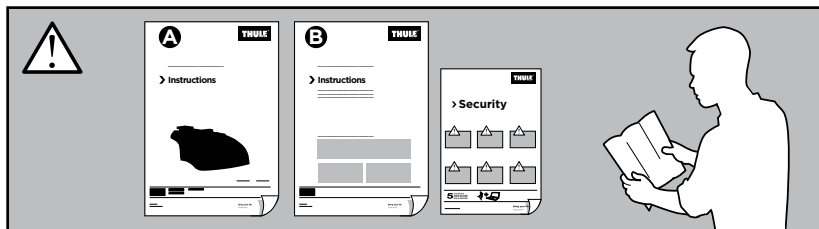

ISO 11154-E

183143

C.20150529
509-3143-01

Bring your life

thule.com

 07 / 13 x 1
 07 / 14 x 1
 08 / 15 x 1
 08 / 16 x 1
 15 x 1
 16 x 1
 17 x 1
 18 x 1
 50616 x 4
 50751 x 4
 RR FR
 FL RL x 1
 B THULE
 > Instructions
 x 1
 A
 16 mm x 8
 5 mm x 1

1

08/16 15 FL ↓ ↓ FR 16 07/13
 08/15 17 ↓ RL ↓ RR 18 07/14

2

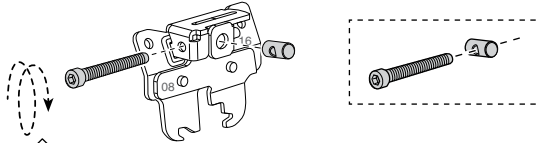
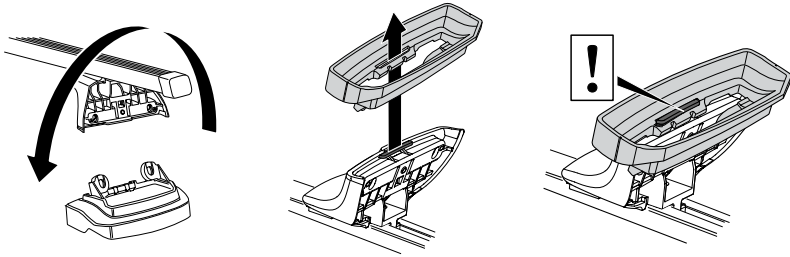

- | | | |
|-------------------------------------|-------------------------------------|----------------------------------|
| EN Only a few turns | ET Ainult mõni pööre | RO Doar câteva rotiri |
| DE Nur wenige Umdrehungen | LV Tikai dažī apgriezieni | HU Csak néhány fordítás |
| FR Quelques tours uniquement | LT Tik keli pasukimai | EL Μόνο λίγες περιστροφές |
| NL Slechts enkele slagen | PL Wystarczy kilka obrotów | TR Yalnızca birkaç tur |
| IT Solo qualche giro | RU Только несколько оборотов | AR بعض دورات فقط |
| ES Sólo algunas vueltas | UK Лише декілька обертів | HE רק מספר סיבובים |
| PT Apenas algumas voltas | BG Само няколко завъртания | ZH 仅几圈 |
| SV Endast några varv | CS Pouze několik otáček | JA 2～3回転のみ |
| DK Kun nogle få omgange | SK Len niekoľko otáčok | KO 몇 번만 돌리면 됨 |
| NO Bare noen få omdreinger | SL Le nekaj obratov | TH เพียงสองสามรอบ |
| FI Vain muutama kierros | HR/BIH Samo nekoliko okreta | |

A

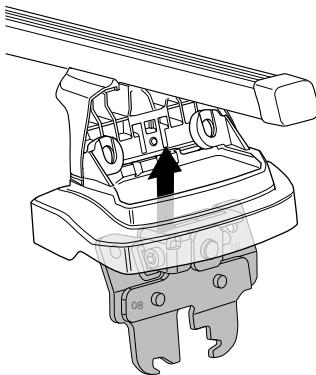

B

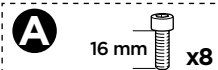
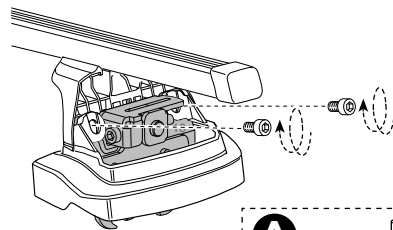

C

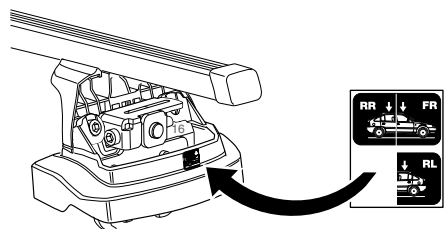

x 1

3

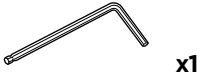

A

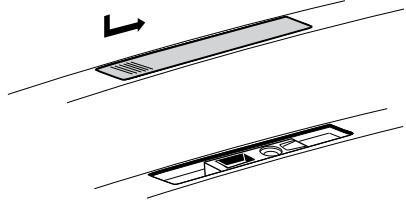
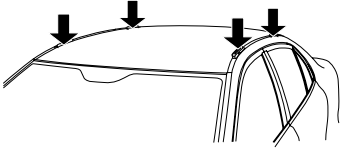

B

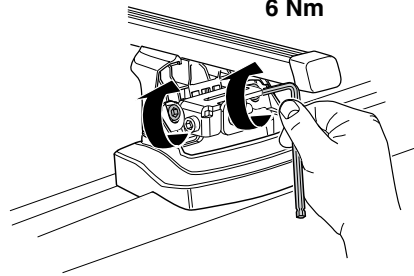
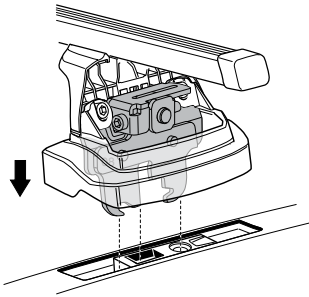

C

